

Dean Wampler
dean.wampler@typesafe.com
@deanwampler
polyglotprogramming.com/talks



YOW! LambdaJam
Brisbane
May 8-9, 2014

Reactive Design, Languages, & Paradigms

Tuesday, May 13, 14

Copyright (c) 2005-2014, Dean Wampler, All Rights Reserved, unless otherwise noted.

Image: Gateway Arch, St. Louis, Missouri, USA.

Special thanks to co-speakers at ReactConf 2014 for great feedback on the original version of this talk.

About
me

THE
Compleat Troller,
OR,
THE ART
OF
TROLLING.

WITH

A Description of all the Utensils,
Instruments, Tackling, and Mate-
rials requisite thereto : With Rules
and Directions how to use them

Tuesday, May 13, 14

photo: https://twitter.com/john_overholt/status/447431985750106112/photo/1

Disclaimer

It's inevitable that a survey talk like this makes generalizations. In reality, good people can make almost any approach work, even if the approach is suboptimal.

Tuesday, May 13, 14

I'm going to criticize some traditionally-good ideas like OO, which makes a lot of sense for UI widgets and even traditional, low-performance enterprise apps. We're discussing reactive apps that need high performance, which means minimal code, minimal performance killing abstractions, etc.

Times change, the projects we implement change, and our toolboxes keep expanding...

Disclaimer

*Ideas I criticize here might be right
in other contexts...*

Tuesday, May 13, 14

I'm going to criticize some traditionally-good ideas like OO, which makes a lot of sense for UI widgets and even traditional, low-performance enterprise apps. We're discussing reactive apps that need high performance, which means minimal code, minimal performance killing abstractions, etc.

Times change, the projects we implement change, and our toolboxes keep expanding...

Disclaimer

*Past performance does not
guarantee future results...*

... and there is no spoon.



Four Traits of Reactive Programming

reactivemanifesto.org

Tuesday, May 13, 14

Photo: Foggy day in Chicago.

Loosely coupled,
composable,
distributed.
Network problems
first-class.

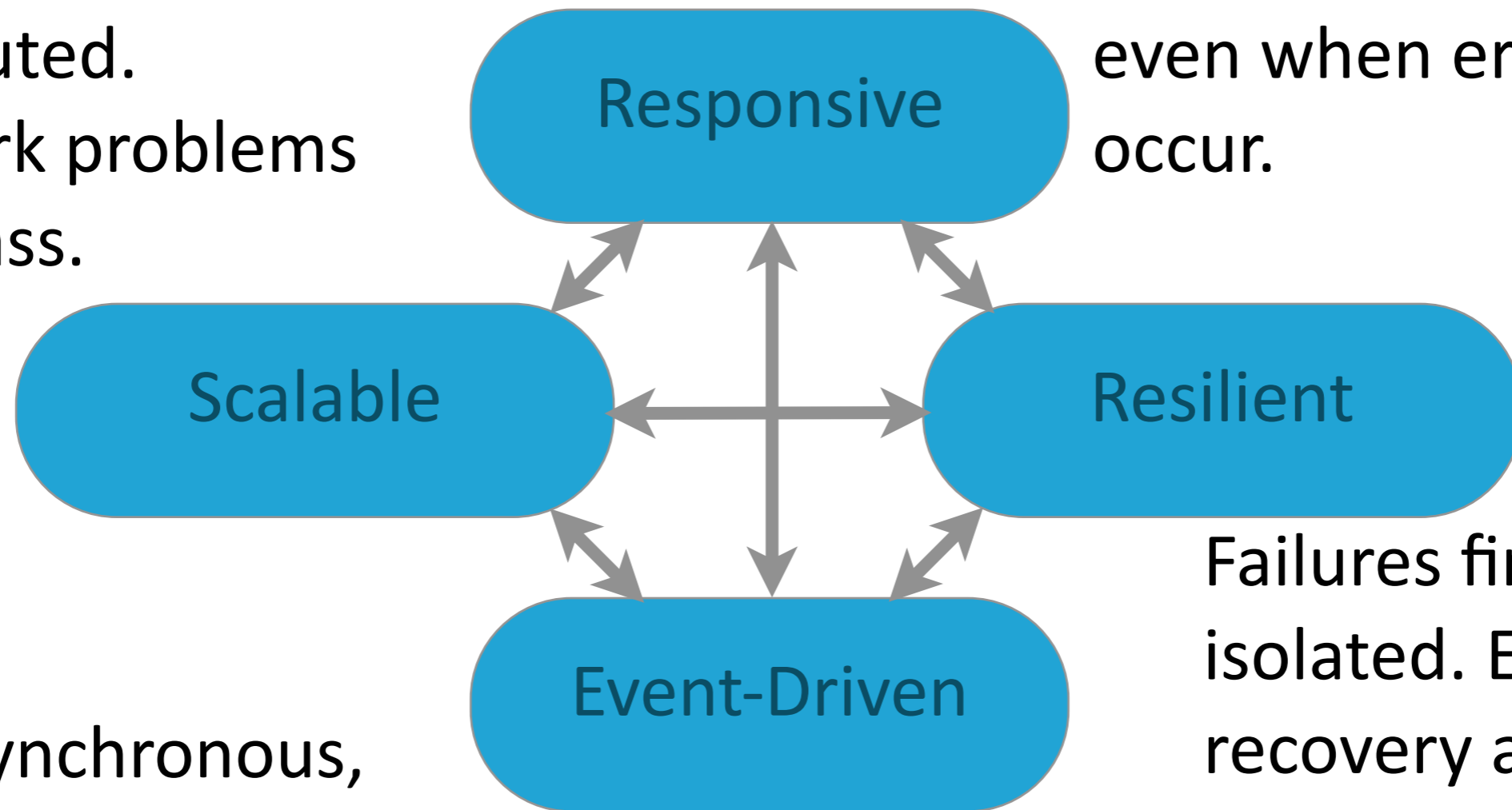

Must respond,
even when errors
occur.

Failures first-class,
isolated. Errors/
recovery are just
other events.

Asynchronous,
non-blocking. Facts
as events are pushed.

reactivemanifesto.org

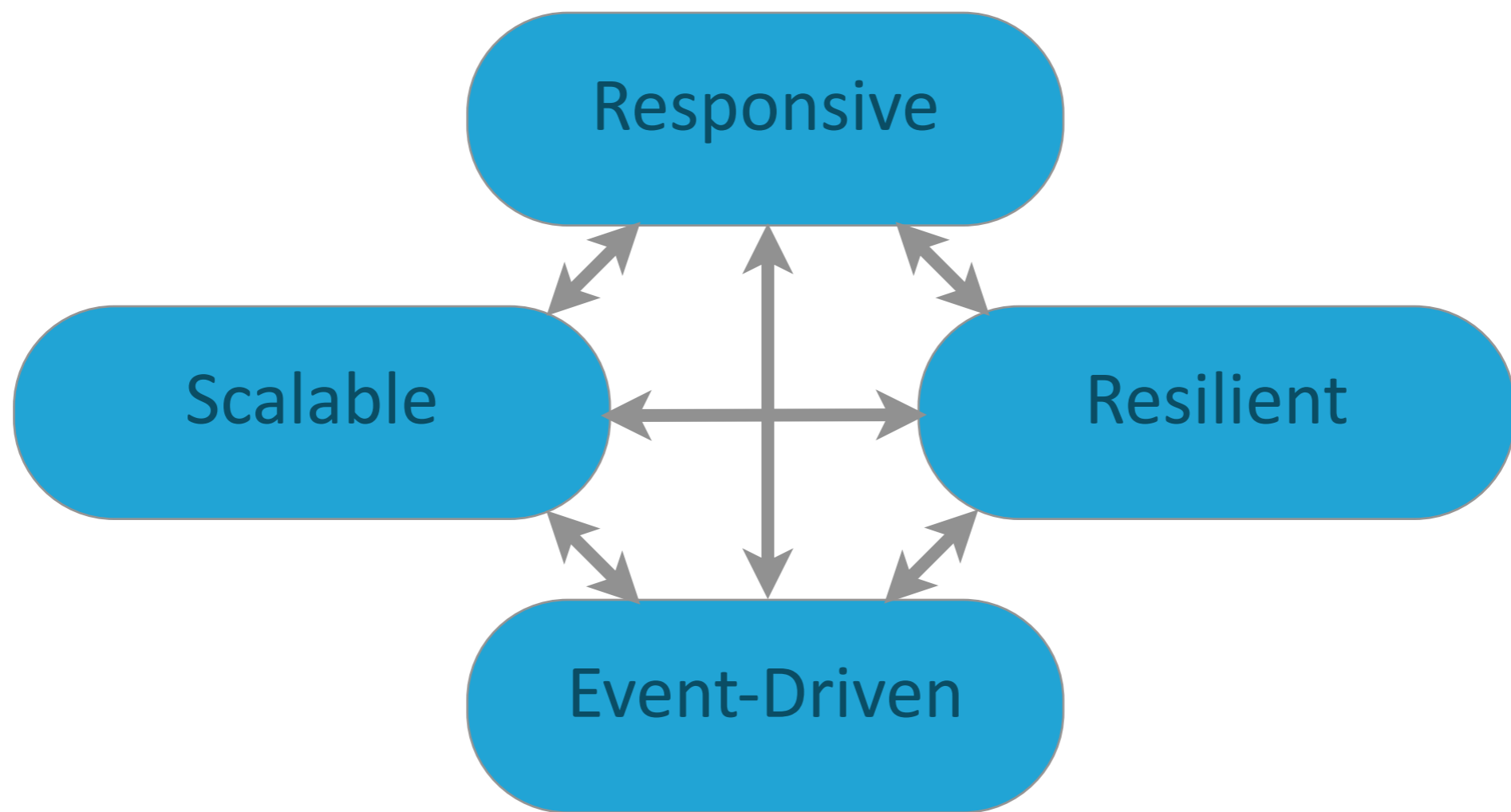

We'll use this graphic to assess how well different “paradigms” and tools support these traits.

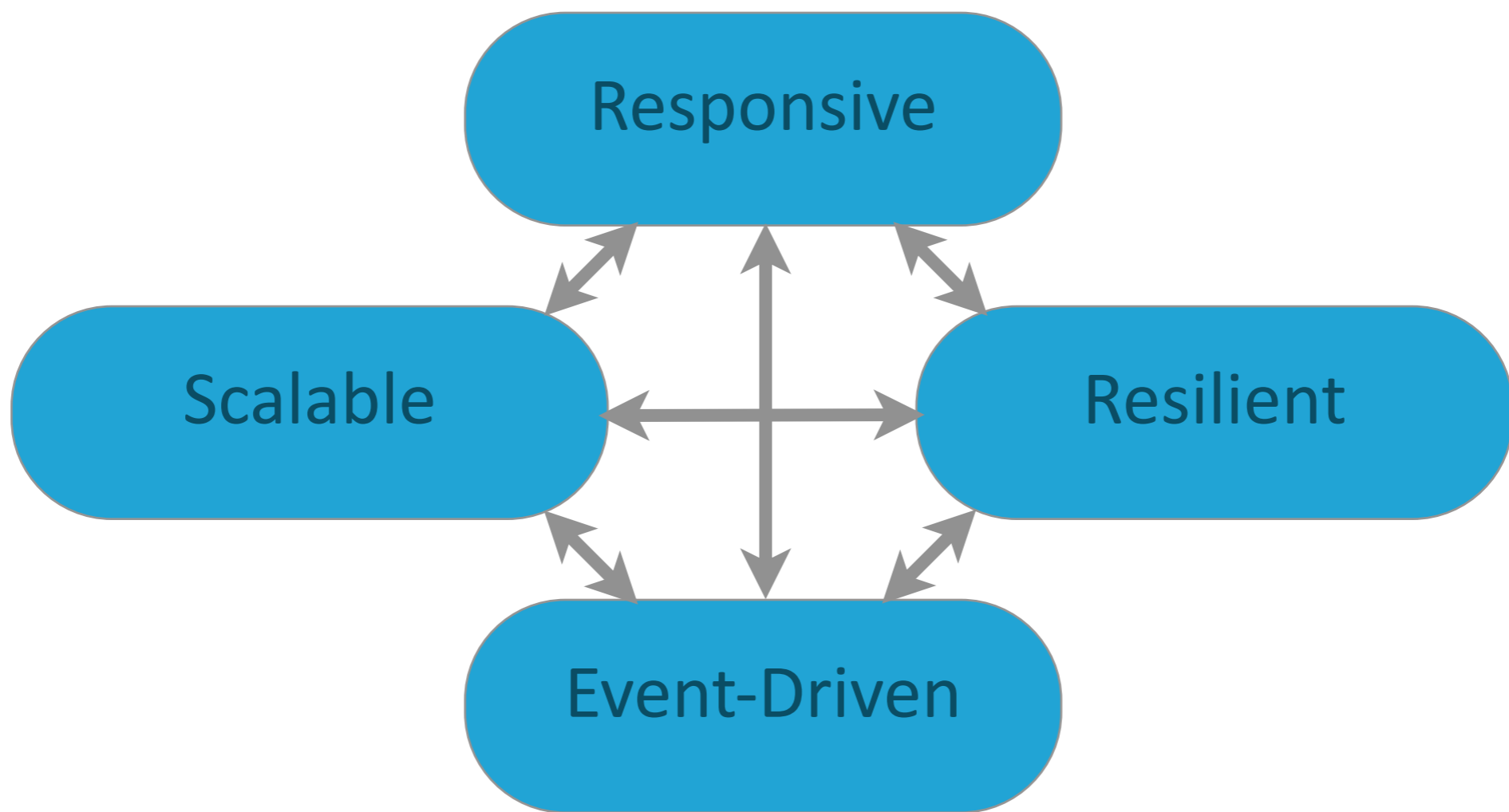

Color code:

Good

Missing Pieces

Problematic

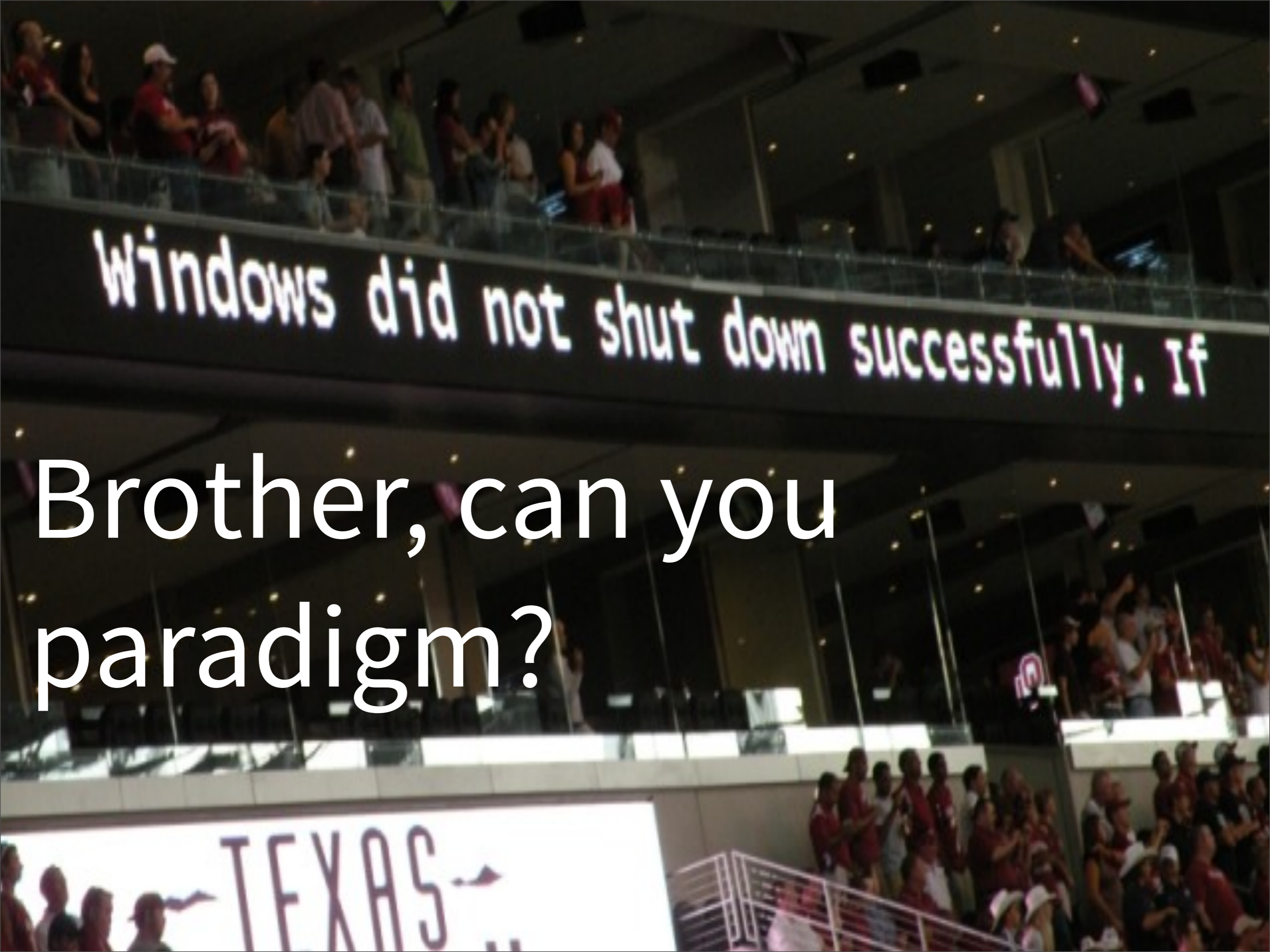

Windows did not shut down successfully. If

Brother, can you
paradigm?

TEXAS

Tuesday, May 13, 14
Dallas football stadium (credit: unknown)

OOP



Tuesday, May 13, 14

Photo: Frank Gehry-designed apartment complex in Dusseldorf, Germany.

State and Behavior Are Joined

Tuesday, May 13, 14

Joined in objects. Contrast with FP that separates state (values) and behavior (functions).

Event-driven: A benefit because events make natural objects, but event-handling logic can be obscured by object boundaries.

Scalability: Bad, due to the tendency to over-engineer the implementation by implementing more of the domain model than absolute necessary. This makes it harder to partition the program into “microservices”, limiting scalability. For high-throughput systems, instantiating objects for each “record” can be expensive. Arrays of “columns” are better if a lot of “records” are involved per event (or batches of events).

Responsive: Any code bloat and implementation logic scattered across class boundaries slows down the performance, possibly obscures bugs, and thereby harms responsiveness.

Resilient: Harder to reify Error handling, since it is a cross-cutting concern that cuts across domain object boundaries. Scattered logic (across object boundaries) and state mutation make bugs more likely.

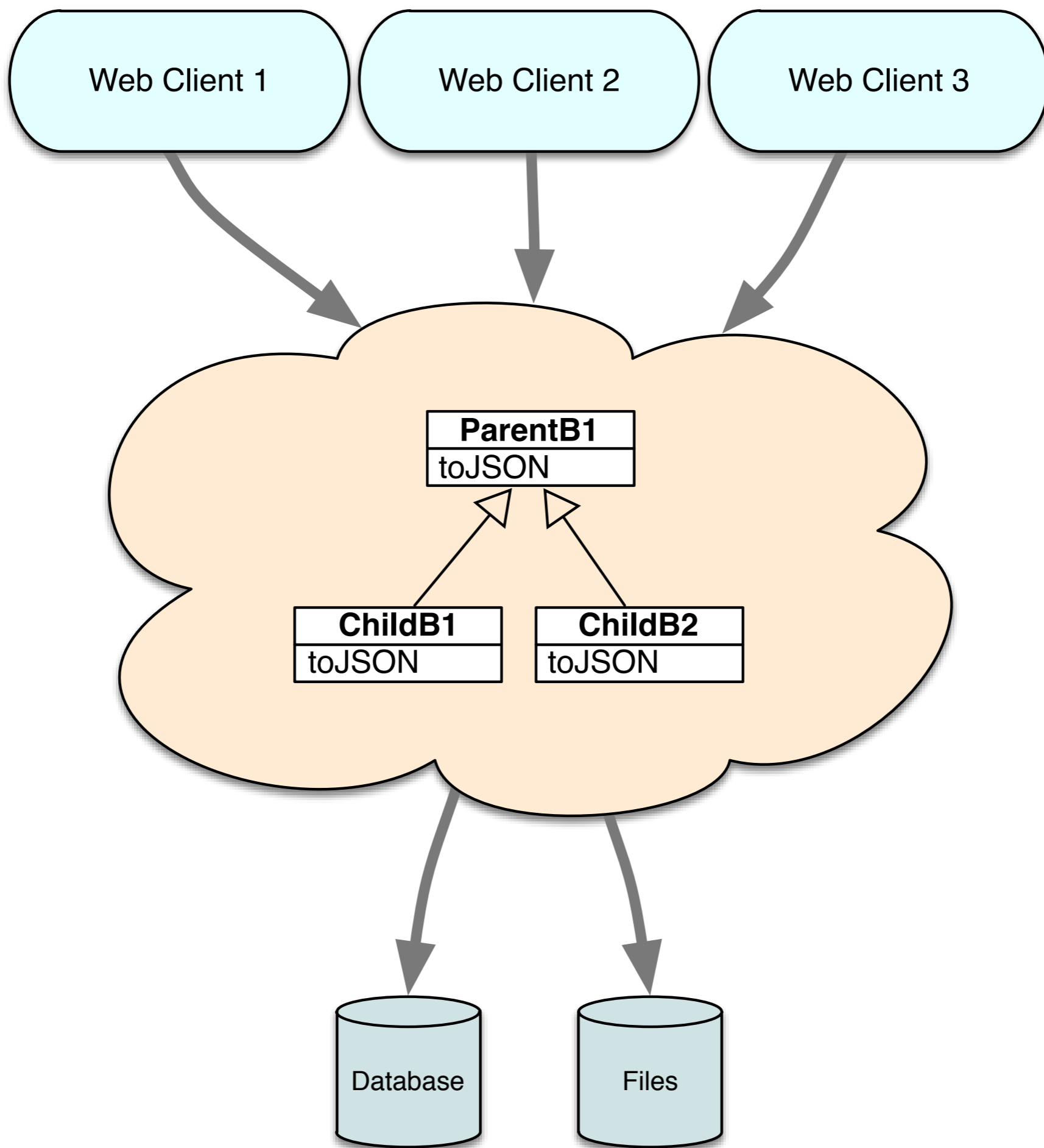

Tuesday, May 13, 14

What most large OO applications look like that I've ever seen. Rich domain models in code that can't be teased apart easily into focused, lightweight, fast services. For example, if a fat "customer" object is needed for lots of user stories, the tendency is to force all code paths through "Customer", rather than having separate implementations, with some code reuse, where appropriate. (We'll come back to this later.)

Example:

What should be in a Customer class?

Tuesday, May 13, 14

What fields should be in this class? What if you and the team next door need different fields and methods? Should you have a Frankenstein class, the superset of required members? Should you have separate Customer classes and abandon a uniform model for the whole organization? Or, since each team is actually getting the Customer fields from a DB result set, should each team just use a tuple for the field values returned (and not return the whole record!), do the work required, then output new tuples (=> records) to the database, report, or whatever? Do the last option...

Claim:

OOP's biggest mistake:
believing you should
implement your
domain model.

Tuesday, May 13, 14

This leads to ad-hoc classes in your code that do very little beyond wrap more fundamental types, primitives and collections. They spread the logic of each user story (or use case, if you prefer) across class boundaries, rather than put it one place, where it's easier to read, analyze, and refactor. They put too much information in the code, beyond the "need to know" amount of code. This leads to bloated applications that are hard to refactor in to separate, microservices. They take up more space in memory, etc.

The ad-hoc classes also undermined reuse, paradoxically, because each invents its own "standards". More fundamental protocols are needed.

State Mutation Is Good

Tuesday, May 13, 14

Preferred over immutability, which requires constructing new objects. FP libraries, which prefer immutable values, have worked hard to implement efficient algorithms for making copies. Most OOP libraries are very inefficient at making copies, making state mutation important for performance. Hence, in typically OOP languages, even “good-enough” performance may require mutating state.

However, “unprincipled” mutable state is a major source of bugs, often hard to find, “action at a distance” bugs. See next slide.

Event-driven: Supports events and state changes well.

Scalable: Mutating state can be very fast, but don’t overlook the overhead of lock logic. Use a lock-free datastructure if you can.

Responsive: Faster performance helps responsiveness, but not if bugs dues to mutation occur.

Resilient: Unprincipled mutation makes the code inherently less resilient.

Mutability

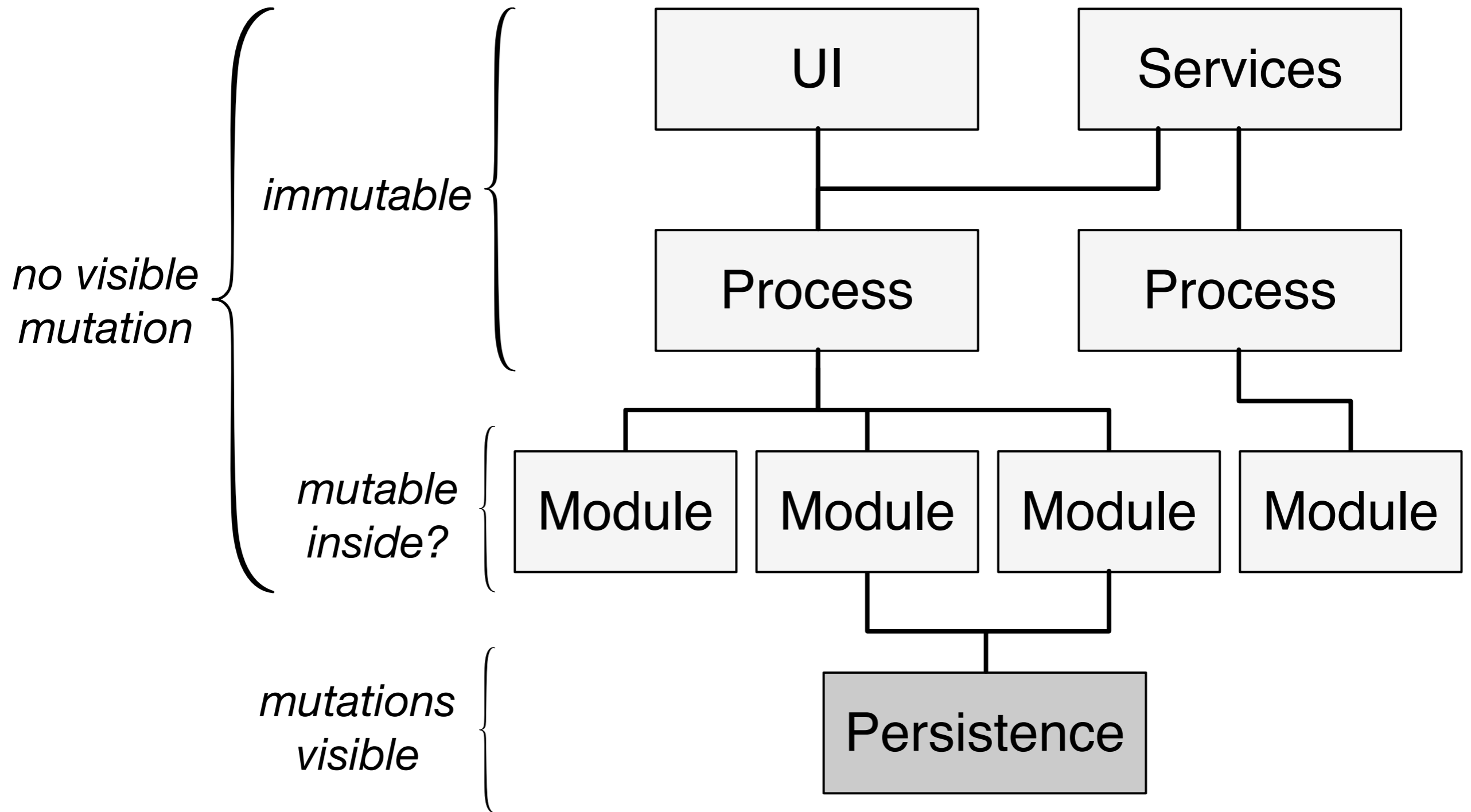

Tuesday, May 13, 14

There are different levels of granularity. Keep mutation invisible inside modules (& the DB).

Mutation can't be eliminated. Even "pure" FP code, which tries to avoid all mutation, has to have some system-level and I/O mutation somewhere. The key is to do it in a principled way, encapsulated where needed, but remain "logically immutable" everywhere else.

Note that in pure FP, state is expressed at any point in time by the stack + the values in scope.

Critique

Loosely coupled,
composable,
distributed.
Network problems
first-class.

Must respond,
even when errors
occur.

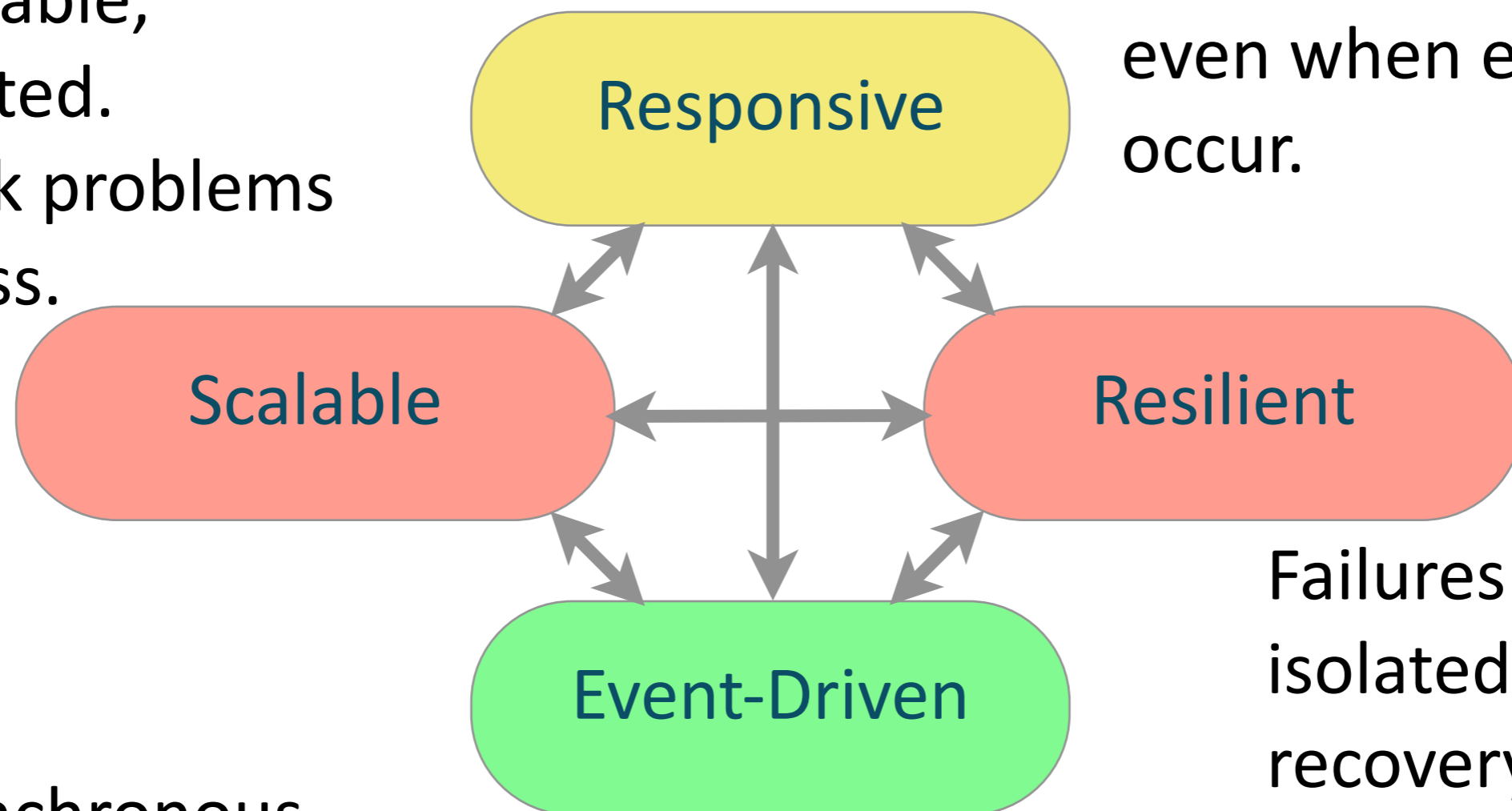

Failures first-class,
isolated. Errors/
recovery are just
other events.

Asynchronous,
non-blocking. Facts
as events are pushed.

Tuesday, May 13, 14

So, how does OOP stand up as a tool for Reactive Programming?

It's good for representing event-driven systems. Actor models have been called object-oriented, matching Kay's description of what he intended. But they suffer in the other traits. Mutation makes loose coupling and scaling very difficult; e.g., it's hard to separate the "model of the world" into separate services. Worse, mutation undermines resilience.

But, here is an OOP Reactive System...

Tuesday, May 13, 14

OOP is not “bad”. Besides RxJava and similar reactive systems implemented in OO languages, there’s this...

AI Robotics

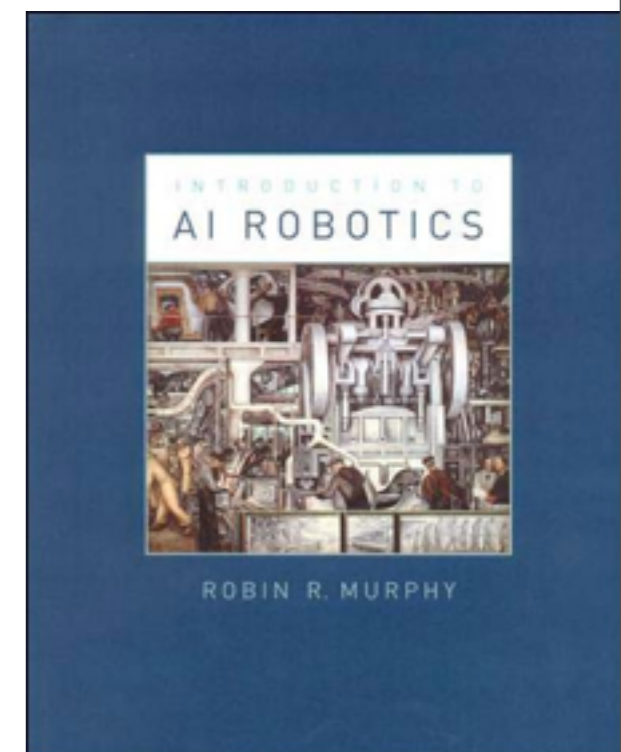
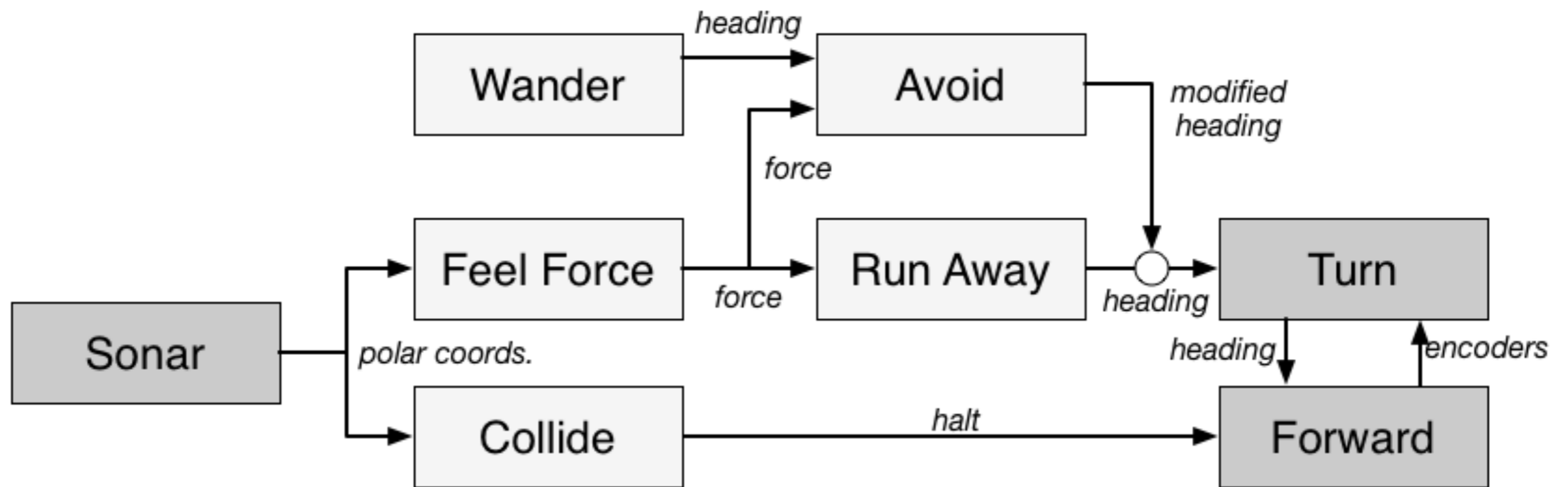

Tuesday, May 13, 14

From "Introduction to AI Robotics", MIT Press, 2000. <http://mitpress.mit.edu/books/introduction-ai-robotics>

Actually called "Reactive Programming" and ~20 years old. For an explanation of this example and more background details, see the bonus slides.

Alan Kay

“OOP to me means only messaging, local retention and protection, hiding state-process, and extreme late-binding of all things.”

Alan Kay

“Actually I made up the term “object-oriented”, and I can tell you I did not have C++ in mind.”

Tuesday, May 13, 14

http://userpage.fu-berlin.de/~ram/pub/pub_jf47ht81Ht/doc_kay_oop_en and http://en.wikiquote.org/wiki/Alan_Kay

Kay's vision of OO is closer to what we really want for Reactive.

Domain Driven Design



A system-level
approach to OOP

Tuesday, May 13, 14

DDD is very OOP-centric, although efforts are being made to make it applicable to alternative “paradigms”, like functional programming.
Photo: Hancock Building in Chicago on a foggy day.

Model the Domain

Tuesday, May 13, 14

You spend a lot of time understanding the domain and modeling sections of it, relative to use cases, etc. I.e., a domain model for payroll calculation in an HR app. has different concepts than a model for selecting retirement investment options in the same app.

Event Driven: It's important to understand the domain and DDD has events as a first-class concept, so it helps.

Scalable: Modeling and implementing the model in code only makes the aforementioned OOP scaling problems worse. DDD is really an OO approach that encourages implementing objects, which I've argued is unnecessary, although attempts are being made to expand DDD to FP, etc.

Responsive: Doesn't offer a lot of help for more responsiveness concerns.

Resilient: Does model errors, but doesn't provide guidance for error handling.

Claim: Models *should* be Anemic.

Tuesday, May 13, 14

In DDD, models should fully encapsulate state and behavior. Anemic models separate the two concepts, where the class instances are just “structures” and static methods are used to manipulate the data, an “anti-pattern” in DDD. Instead, I’ll argue in the functional programming section that state and behavior should be separated, so Anemic models are preferred!

Objects

- **Entity:** Stateful, defined by its identity and lifetime.
- **Value Object:** Encapsulates immutable state.
- **Aggregate:** Bound-together objects. Changes controlled by the “root” entity.
- **Domain Event:** An event of interest, modeled as an object.
- **Service:** Bucket for an operation that doesn't naturally belong to an object.
- **Repository:** Abstraction for a data store.
- **Factory:** Abstraction for instance construction.

Objects

- **Entity:** Stateful, defined by its identity and lifetime.
- **Value Object:** Encapsulates immutable state.
- **Aggregate:** Bound-together objects. Changes controlled by the “root” entity.

- **Domain Event:** An event of interest, modeled as an object.
- **Service:** Bucket for an operation that doesn't naturally belong to an object.
- **Repository:** Abstraction for a data store.
- **Factory:** Abstraction for instance construction.

Good

Tuesday, May 13, 14

It's good that events are an important concept in DDD, as are services and factories, although the way service is defined is too narrow and introverted. I don't care if a function is an instance or a static member. A service is process providing a “service” that I communicate with over REST, sockets, etc.

Objects

- **Entity:** Stateful, defined by its identity and lifetime.
- **Value Object:** Encapsulates immutable state.
- **Aggregate:** Bound-together objects. Changes controlled by the “root” entity.
- **Domain Event:** An event of interest, modeled as an object.
- **Service:** Bucket for an operation that doesn't naturally belong to an object.
- **Repository:** Abstraction for a data store.
- **Factory:** Abstraction for instance construction *Avoid ORM!*

Tuesday, May 13, 14

Don't use ORMs. Don't abstract the datastore. Embrace it and its details, because you need to exploit them for maximal performance. ORMs undermine performance and limit effective use of the datastore.

Objects

- **Entity:** Stateful, defined by its identity and lifetime.
- **Value Object:** Encapsulates immutable state.
- **Aggregate:** Bound-together objects. Changes controlled by the “root” entity.
- **Domain Event:** An event of interest, *Use Collections!* object.
- **Service:** Bucket for an operation that doesn't naturally belong to an object.
- **Repository:** Abstraction for a data store.
- **Factory:** Abstraction for instance construction.

Tuesday, May 13, 14

NEVER create ad-hoc “aggregations” of things. Use (immutable) collections because of their powerful operations (filter, map, fold, groupby, etc.) that you'll either reimplement yourself or do something else that's substandard.

Objects

- **Entity:** Mutable state, defined by its identity and lifetime.
- **Value Object:** Encapsulates immutable state.
- **Aggregate:** Bound-together objects. Changes controlled by the “root” entity. *Make mutable objects the exception*
- **Domain Event:** An event of interest, modeled as an object.
- **Service:** Bucket for an operation that doesn't naturally belong to an object.
- **Repository:** Abstraction for a data store.
- **Factory:** Abstraction for instance construction.

Tuesday, May 13, 14

By default, all objects should be immutable values. Mutable objects should be the exception.

Ubiquitous Language

Tuesday, May 13, 14

All team members use the same domain language. It sounded like a good idea, but leads to bloated, inflexible code. Instead, developers should only put as much of the domain in code as they absolute need, but otherwise, use an appropriate “implementation language”.

Event Driven: It’s important to understand the domain and DDD has events as a first-class concept, so it helps.

Scalable: Modeling and implementing the model in code only makes the aforementioned scaling problems worse.

Responsive: Doesn’t offer a lot of help for more responsiveness concerns.

Resilient: Does model errors, but doesn’t provide guidance for error handling.

Critique

Loosely coupled,
composable,
distributed.
Network problems
first-class.

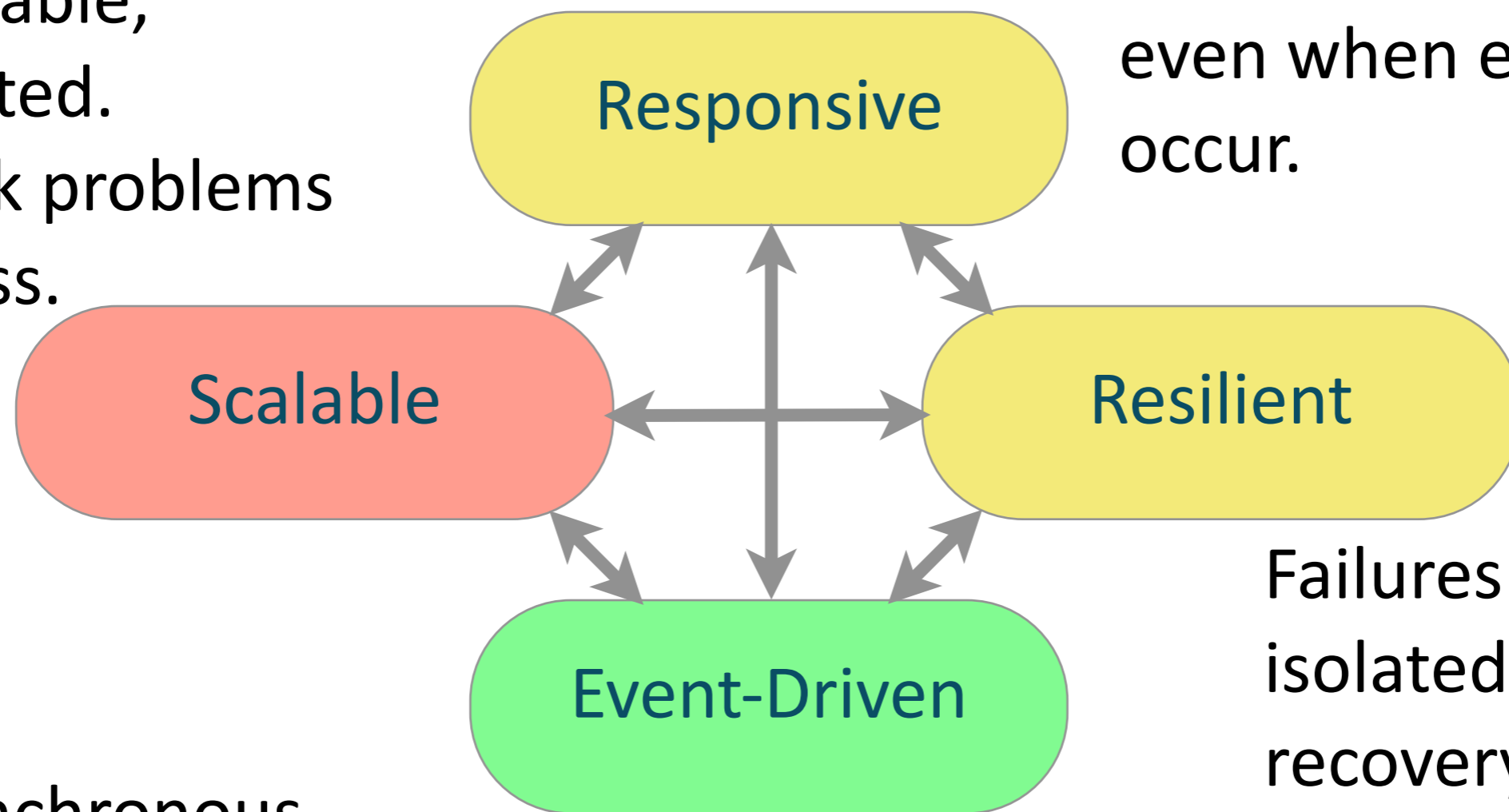

Must respond,
even when errors
occur.

Failures first-class,
isolated. Errors/
recovery are just
other events.

Asynchronous,
non-blocking. Facts
as events are pushed.

Tuesday, May 13, 14

Since DDD is primarily a design approach, with more abstract concepts about the implementation, the critique is based on how well it helps us arrive at a good reactive system. I think DDD concepts can be used in a non-OOP way, but few practitioners actually see it that way. Instead, I see DDD practitioners forcing a model onto reactive systems, like Akka, that add complexity and little value. There's a better way...

DDD encourages
understanding
of the domain, but
don't implement
the models!

For a more functional approach to DDD:

debasishg.blogspot.com.au

Tuesday, May 13, 14

Start with this blog by Debasish Ghosh, such as this recent post: <http://debasishg.blogspot.com.au/2014/04/functional-patterns-in-domain-modeling.html> (his most recent at the time of this writing. Some older posts also discuss this topic.

In general, his blog is excellent.

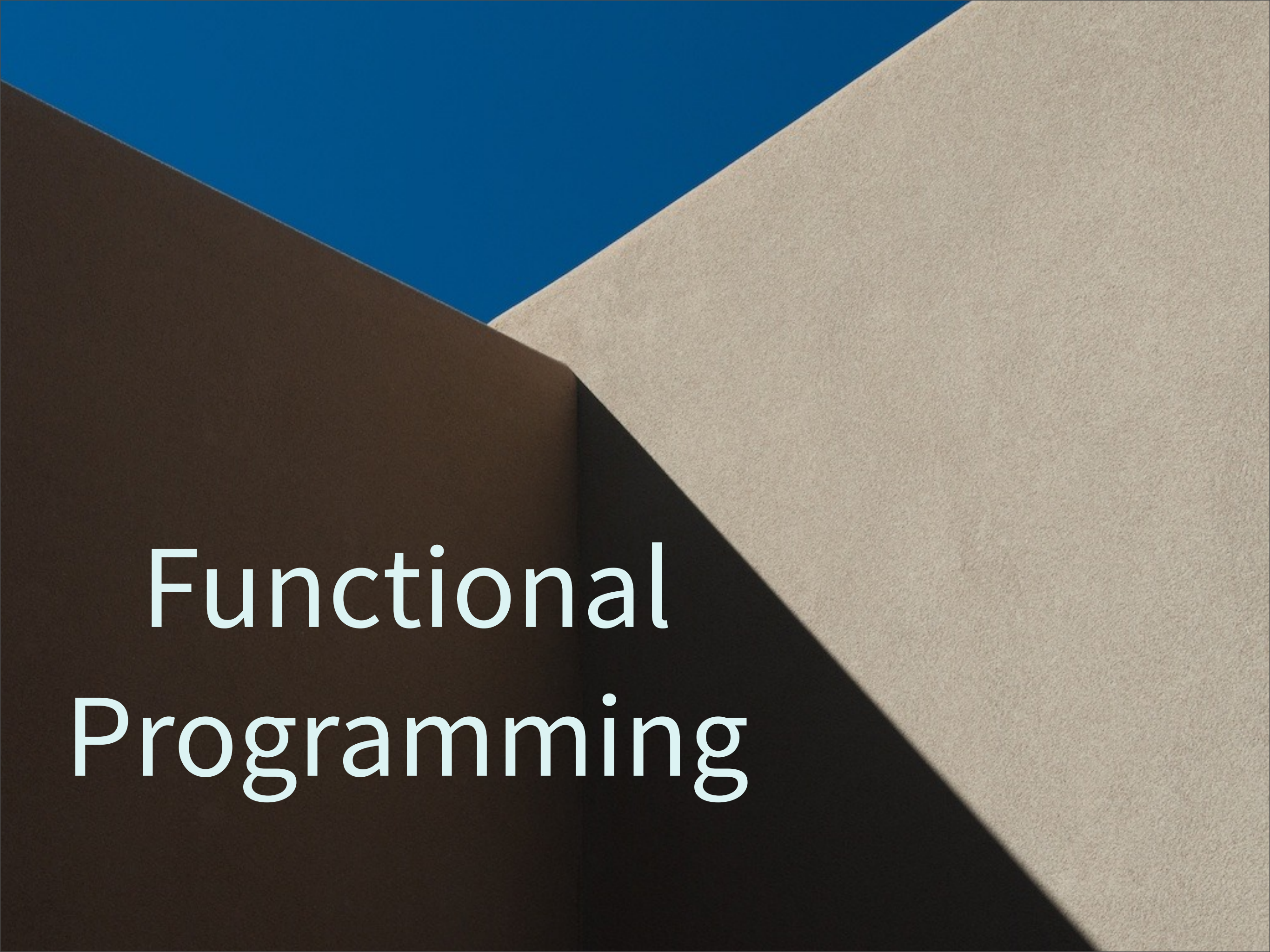

Functional Programming

Tuesday, May 13, 14

Mathematics

Tuesday, May 13, 14

“Maths” - Commonwealth countries, “math” - US, because we’re slower... The formalism of Mathematics brings better correctness to code than ad-hoc approaches like OOP and imperative programming, in general.

Event-Driven: Model the state machine driven by the events.

Scalable: The rigor of mathematics can help you avoid unnecessary logic and partition the full set of behavior into disjoint sets (how’s that for using buzz words...).

Resilient: Model error handling.

For an interesting use of “math(s)” in Big Data, see <http://www.infoq.com/presentations/abstract-algebra-analytics>.

Function Composition

(but needs modules)

Tuesday, May 13, 14

Complex behaviors composed of focused, side-effect free, fine-grained functions.

Event-driven: Easy to compose handlers.

Scalable: Small, concise expressions minimize resource overhead. Also benefits the SW-development burden, also if the API is fast, then concise code invoking it makes it easier for users to exploit that performance.

Responsive: Uniform handling of errors and normal logic (Erik Meijer discussed this in his talk).

In general, promotes natural separation of concerns leading to better cohesion and low coupling.

Immutable Values

Tuesday, May 13, 14

Data “cells” are immutable values.

Event-Driven: The stream metaphor with events that aren’t modified, but replaced, filtered, etc. is natural in FP.

Scalable: On the micro-level, immutability is slower than modifying a value, due to the copy overhead (despite very efficient copy algos.) and probably more cache incoherency (because you have two instances, not one). At the macro scale, mutable values forces extra complexity to coordinate access. So, except when you have a very focused module that controls access, immutability is probably faster or at least more reliably (by avoiding bugs due to mutations).

Resilient: Minimizes bugs.

Referential Transparency

Tuesday, May 13, 14

Replace function calls with the values they return. Reuse functions in any context. Caching (“memoization”) is an example. This is only possible with side-effect free functions and immutable values.

Resilient: Side-effect-free functions are much easier to analyze, even replace, so they are less likely to be buggy.

Scalability and responsiveness: Memoization improves performance.

Separation of State and Behavior

Anemic models, for the win...

Tuesday, May 13, 14

Functions are separate from values representing state. Functions are *applied* to data. The same operations can be used with any collection, for example. Greatly reduces code bloat through better, more fine-grained reuse. Greater flexibility to compose behaviors. Contrast with Object-Oriented Programming.

Event-Driven: New events can be handled by existing logic. New logic can be added to handle existing events.

Scalable & Responsive: Smaller code base improves resource utilization.

Resilient: Easier to reify exceptions and implement recovery logic.

:

Critique

Loosely coupled,
composable,
distributed.
Network problems
first-class.

Must respond,
even when errors
occur.

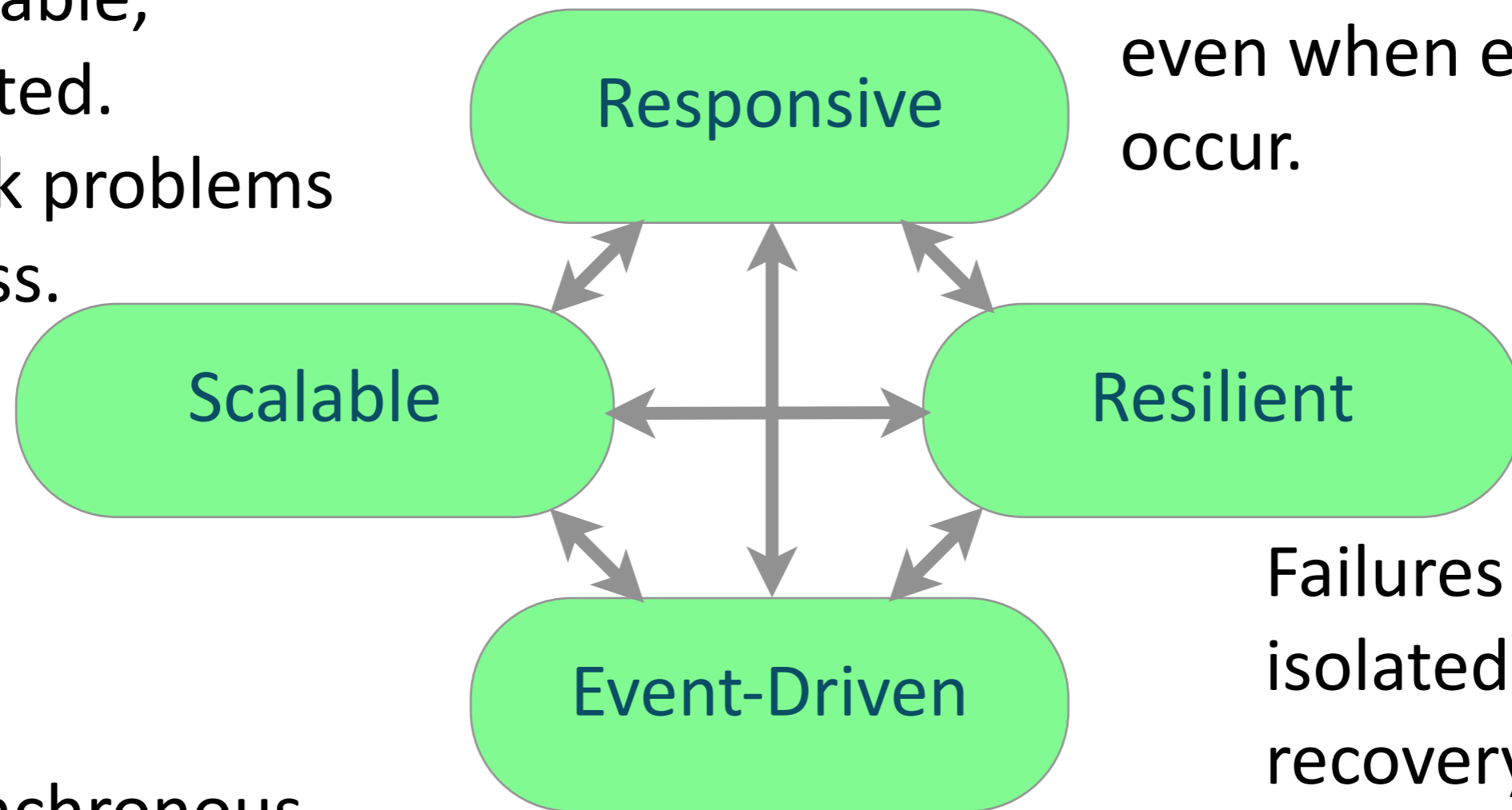

Failures first-class,
isolated. Errors/
recovery are just
other events.

Asynchronous,
non-blocking. Facts
as events are pushed.

Tuesday, May 13, 14

FP is the most natural approach for the Reactive Programming.

I claim it provides the core concepts that are best for addressing the 4 traits, but specific libraries are still required to implement the particulars. Also, there will be exceptions that you make for performance, such as mutable, lock-free queues. See Martin Thompson's talk at React Conf 2014!

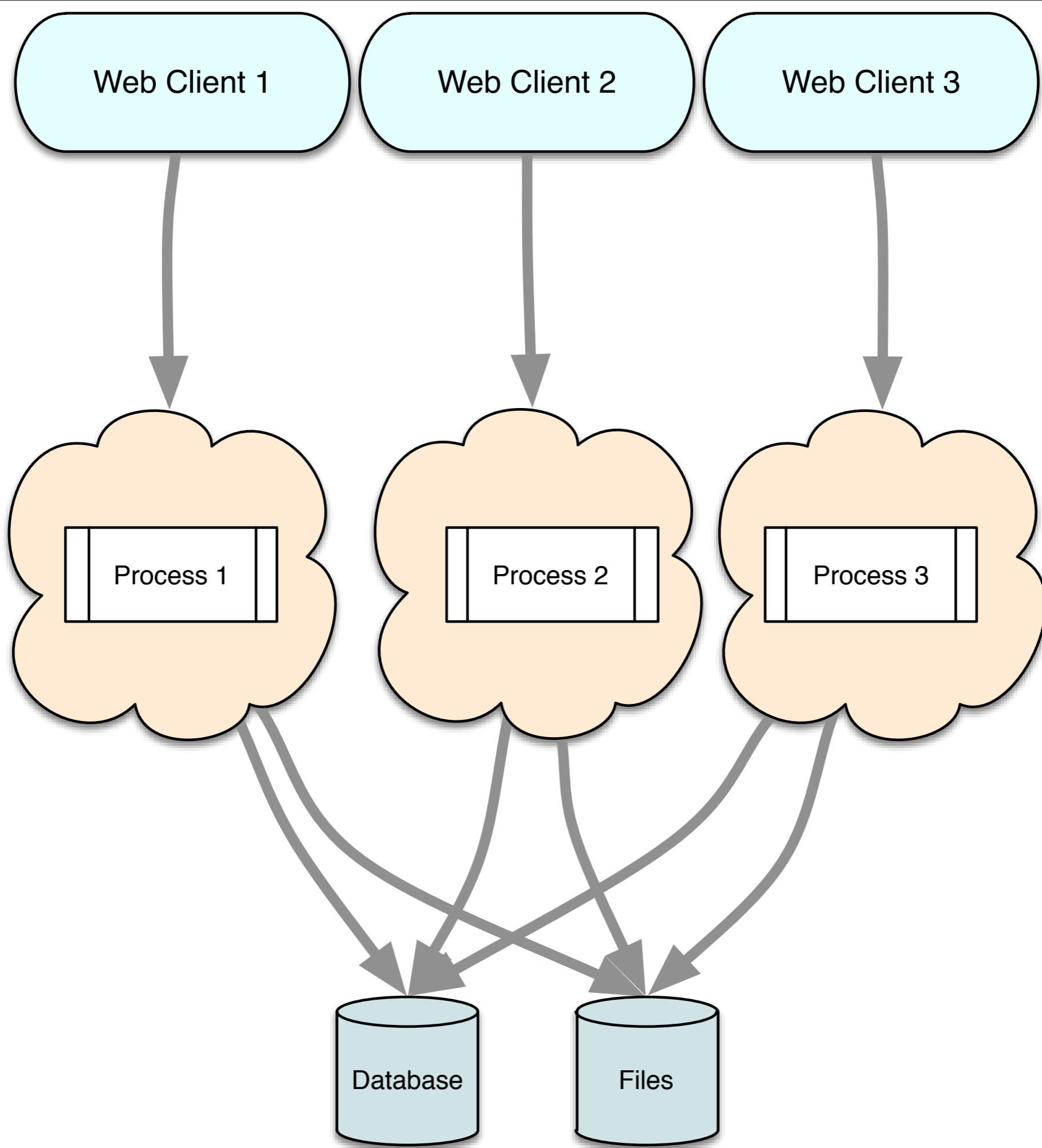

Tuesday, May 13, 14

... makes it easier to construct *microservices* that can be sharded (for load scaling) and replicated (for resilience).

Claim:
SW systems are just
data-processing
systems.

Tuesday, May 13, 14

This seems like a trivial statement, but what I mean is that all programs, at the end of the day, just open input sources of data, read them, perform some sort of processing, then write the results to output syncs. That's it. All other "ceremony" for design is embellishment on this essential truth.

A computer only does
what we tell it...

... We have to think
precisely like a
computer...

... Mathematics is our
best, precise language.

*An example:
“Word Count” in
Hadoop MapReduce*

```

import org.apache.hadoop.io.*;
import org.apache.hadoop.mapred.*;
import java.util.StringTokenizer;

class WCMapper extends MapReduceBase
    implements Mapper<LongWritable, Text, Text, IntWritable> {

    static final IntWritable one = new IntWritable(1);
    static final Text word = new Text(); // Value will be set in a non-thread-safe way!

    @Override
    public void map(LongWritable key, Text valueDocContents,
        OutputCollector<Text, IntWritable> output, Reporter reporter) {
        String[] tokens = valueDocContents.toString.split("\\s+");
        for (String wordString: tokens) {
            if (wordString.length > 0) {
                word.set(wordString.toLowerCase());
                output.collect(word, one);
            }
        }
    }
}

class Reduce extends MapReduceBase
    implements Reducer[Text, IntWritable, Text, IntWritable] {

    public void reduce(Text keyWord, java.util.Iterator<IntWritable> valuesCounts,
        OutputCollector<Text, IntWritable> output, Reporter reporter) {
        int totalCount = 0;
        while (valuesCounts.hasNext) {
            totalCount += valuesCounts.next.get();
        }
        output.collect(keyWord, new IntWritable(totalCount));
    }
}

```

Java API

Tuesday, May 13, 14

“WordCount” in the Hadoop MapReduce Java API. Too small to read and I omitted about 25% of the code, the main routine! This is a very simple algo, yet a lot of boilerplate is required. It’s true there are better Java APIs, not so low level and full of infrastructure boilerplate, but the fundamental problem is one of not providing the right reusable idioms for data-centric computation. (To be fair, the issue improves considerably with Java 8’s lambdas and updated collections.)

```

import org.apache.spark.SparkContext

object WordCountSpark {
  def main(args: Array[String]) {
    val ctx = new SparkContext(...)
    val file = ctx.textFile(args(0))
    val counts = file.flatMap(
      line => line.split("\\W+"))
      .map(word => (word, 1))
      .reduceByKey(_ + _)
    counts.saveAsTextFile(args(1))
  }
}

```

Spark

Tuesday, May 13, 14

Spark is emerging as the de facto replacement for the Java API, in part due to much drastically better performance, but also LOOK AT THIS CODE! It's amazingly concise and to the point. It's not just due to Scala, it's because functional, mathematical idioms are natural fits for dataflows.

Note the verbs - method calls - and relatively few nouns. The verbs are the work we need to do and we don't spend a lot of time on structural details that are besides the point.

```
import org.apache.spark.SparkContext

object WordCountSpark {
  def main(args: Array[String]) {
    val ctx = new SparkContext(...)
    val file = ctx.textFile(args(0))
    val counts = file.flatMap(
      line => line.split("\\W+")
        .map(word => (word, 1))
        .reduceByKey(_ + _)
    ).saveAsTextFile(args(1))
  }
}
```

Spark

Tuesday, May 13, 14

Because it's so concise, it reduces to a "query on steroids", a script that's no longer a "program", requiring all the usual software development process hassles, but a script we tweak and try, use when it's ready, and discard when it's no longer needed.

I want to return to the simple pleasures of bash programming.

OOP/DDD

VS.

FP?



Tuesday, May 13, 14

To make software better, to implement reactive programs well, we need to start at the smallest of foundations, the micro design idioms, and work our way up.

Top-down approaches like OOP & DDD are top-down and don't provide the foundation we need. Functional Programming does.



Bounded Queues

Tuesday, May 13, 14

Unbounded
queues crash.

Bounded queues
require backpressure.

Critique

Loosely coupled,
composable,
distributed.
Network problems
first-class.

Must respond,
even when errors
occur.

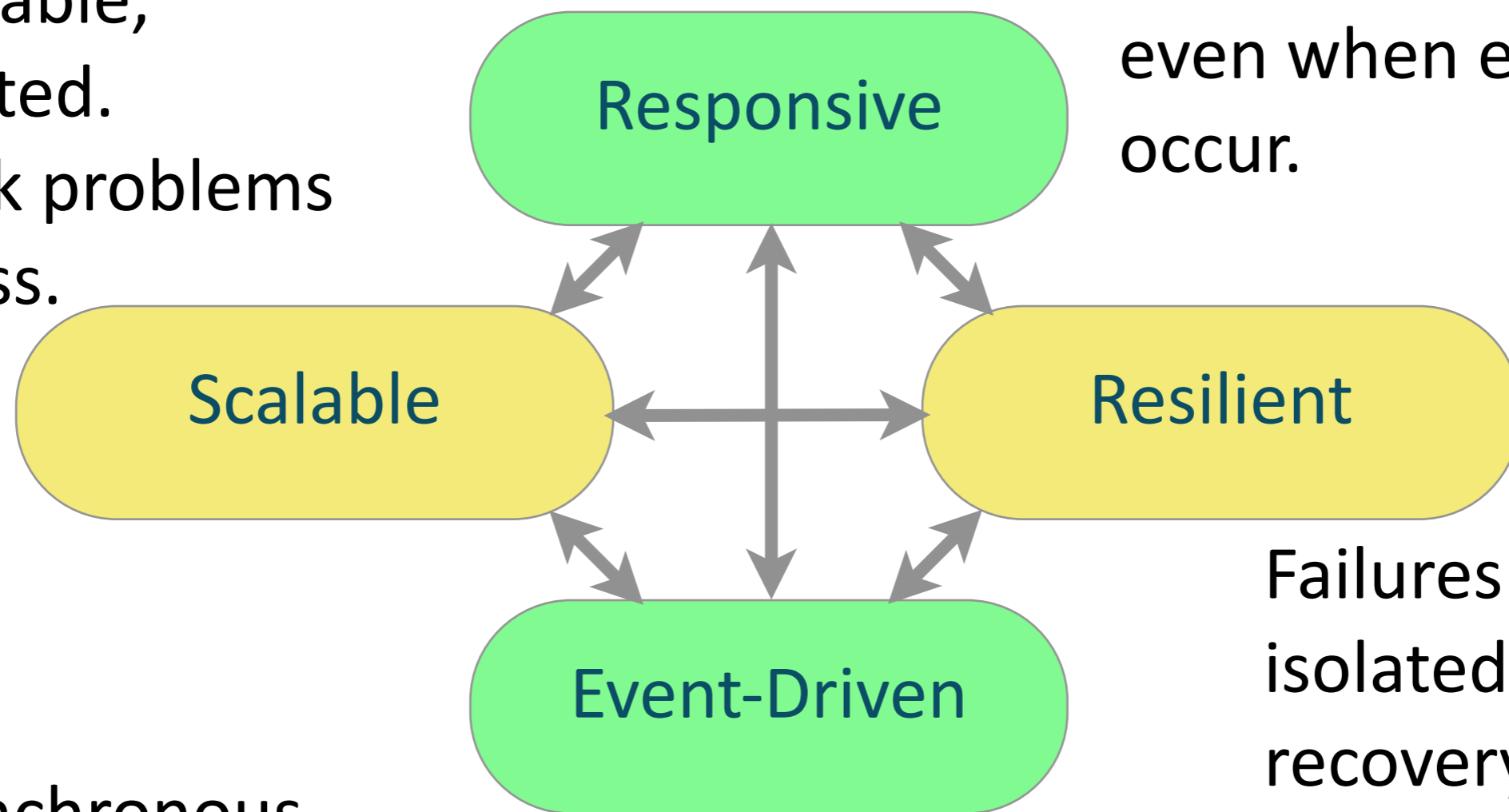

Failures first-class,
isolated. Errors/
recovery are just
other events.

Asynchronous,
non-blocking. Facts
as events are pushed.

Tuesday, May 13, 14

A bounded queue by itself isn't distributed, but you could have multiple copies in a more complete system. The simplest implementations won't provide failure as a first class concept and built-in recovery, although they minimize failure and improve responsiveness with backpressure.

Functional Reactive Programming

Tuesday, May 13, 14

Photo: Building, San Francisco.

Functional Reactive Programming

- **Datatypes of values over time:** Support time-varying values as first class.

`x = mouse.x`

`y = mouse.y`

- **Derived expressions update automatically:**

`a = area(x,y)`

- **Deterministic, fine-grained, and concurrent.**

It's a dataflow system.

Tuesday, May 13, 14

Invented in Haskell ~1997. Recently implemented and spread outside the Haskell community as part of the Elm language for functional GUIs, Evan Czaplicki's graduate thesis project (~2012).

Time-varying values are first class. They could be functions that generate "static" values, or be a stream of values. They can be discrete or continuous.

User's don't have to define update logic to keep derived values in sync, like implement observer logic.

A Scala.React example

```
Reactor.flow { reactor =>
  val path = new Path(
    (reactor.await(mouseDown)).position)
  reactor.loopUntil(mouseUp) {
    val m = reactor.awaitNext(mouseMove)
    path.lineTo(m.position)
    draw(path)
  }
  path.close()
  draw(path)
}
```

From [Deprecating the Observer Pattern with Scala.React](#).

Tuesday, May 13, 14

It's a prototype DSL for writing what looks like imperative, synchronous logic for the the "state machine" of tracking and reacting to a mouse drag operation, but it runs asynchronously (mostly). I've made some minor modifications to the actual example in the paper.

Encapsulates Evolving Mutations of State

Tuesday, May 13, 14

Nicely let's you specify a dataflow of evolving state, modeled as events.

Single Threaded

Tuesday, May 13, 14

Mostly used for the (single) UI event loop. It would be hard to very difficult to have concurrent dataflows that intersect, in part because of the challenge of universal time synchronization. However, you could have many, completely-independent threads of control. So, scalability is a problem and resiliency is a concern as no error recovery mechanism is provided.

Critique

Loosely coupled,
composable,
distributed.
Network problems
first-class.

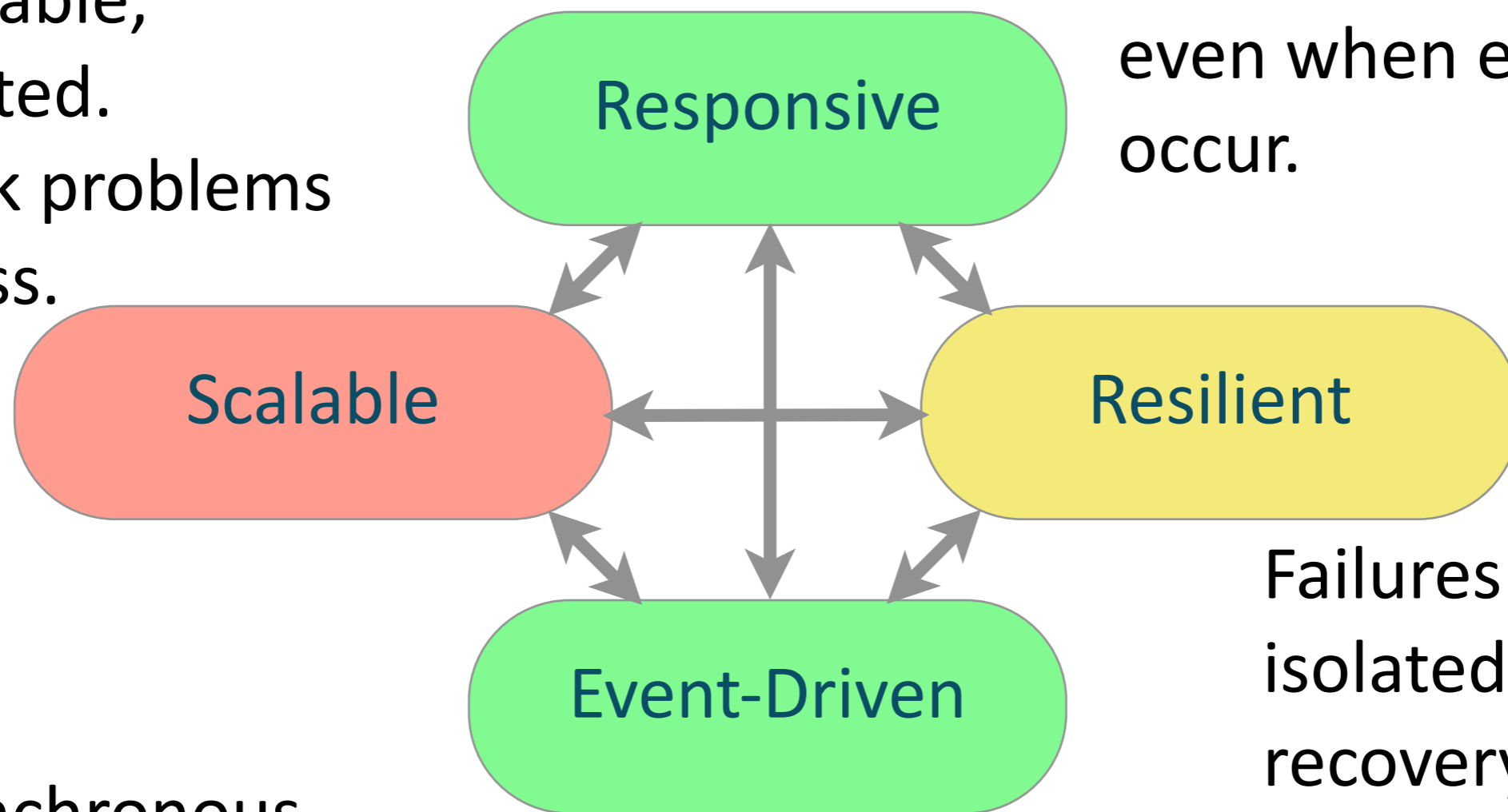

Must respond,
even when errors
occur.

Failures first-class,
isolated. Errors/
recovery are just
other events.

Asynchronous,
non-blocking. Facts
as events are pushed.

Tuesday, May 13, 14

The Elm implementation supports a single event loop thread, so it's not inherently scalable in the usual Reactive way, but it's certainly possible to use separate FRP-managed threads.

Rx



Tuesday, May 13, 14

Not the little blue pill you might be thinking
of...

Reactive Extensions

- **Composable, event-based programs:**
- **Observables:** Async. data streams represented by *observables*.
- **LINQ:** The streams are queried using LINQ (language integrated query).
- **Schedulers:** *parameterize* the concurrency in the streams.

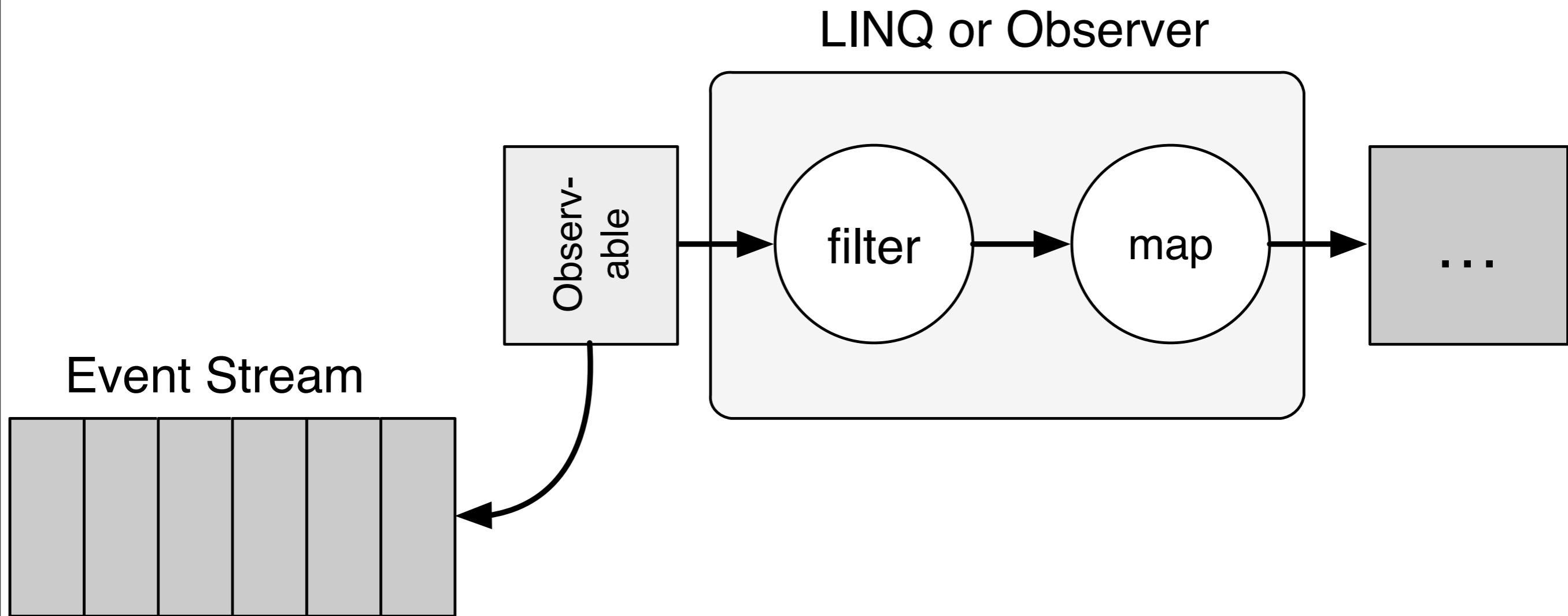

Tuesday, May 13, 14

<https://rx.codeplex.com> - This is the original Microsoft implementation pioneered by Erik Meijer. Other implementations that follow the same model will differ in various ways.

Critique

Loosely coupled,
composable,
distributed.
Network problems
first-class.

Must respond,
even when errors
occur.

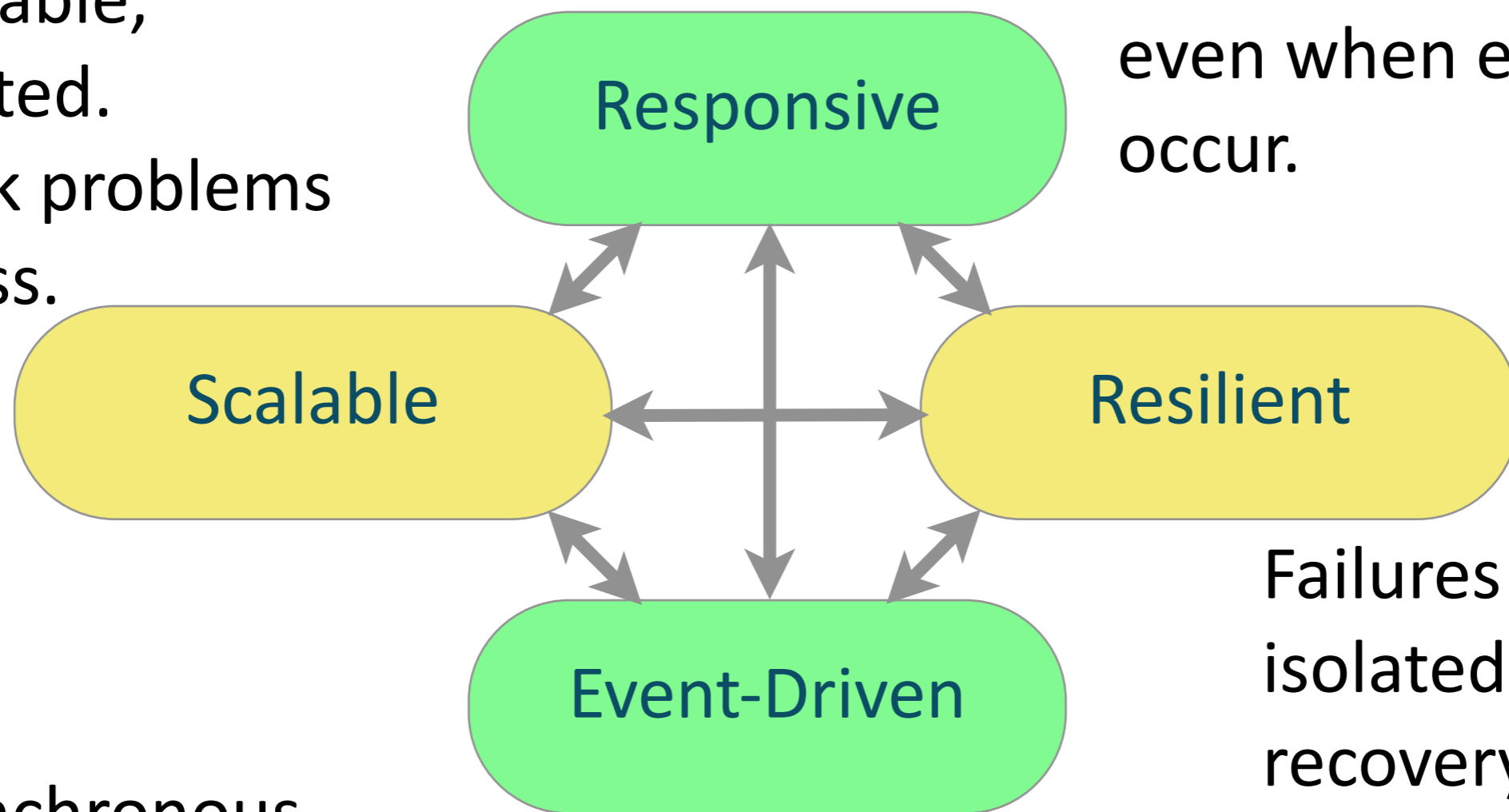

Failures first-class,
isolated. Errors/
recovery are just
other events.

Asynchronous,
non-blocking. Facts
as events are pushed.

Tuesday, May 13, 14

This is a specific, popular approach to reactive. Does it meet all our needs?

This looks a bit more negative than it really is, as I'll discuss.

Event-Driven: Represents events well

Scalability: Increased overhead of instantiating observers and observable increases. Not as easy to scale horizontally without single pipelines, e.g. a farm of event-handler "workers".

Responsive and Resilient: Errors handled naturally as events, although an out-of-band error signaling mechanism would be better and there's no built-in support for back pressure.

Interlude: Callbacks

Tuesday, May 13, 14

We mention using observers. What if we just used them without the rest of Rx?
photo: Looking DOWN the Bright Angel Trail, Grand Canyon National Park.

Callbacks

```
startA(...).onComplete(result1) {  
  x = ... result1 ...  
  startB(x).onComplete(result2) {  
    y = ... result2 ...  
    ...  
  }  
}
```

Imperative!!

Tuesday, May 13, 14

Flow of control is obscured by callback boilerplate.

You can tap into central event loops and it is asynchronous, but typical code leads to Callback Hell where the logic is obscured.

- **Adobe Desktop Apps (2008):**
 - 1/3 of code devoted to event handling.
 - 1/2 of bugs reported occur in this code.

Critique

Loosely coupled,
composable,
distributed.
Network problems
first-class.

Must respond,
even when errors
occur.

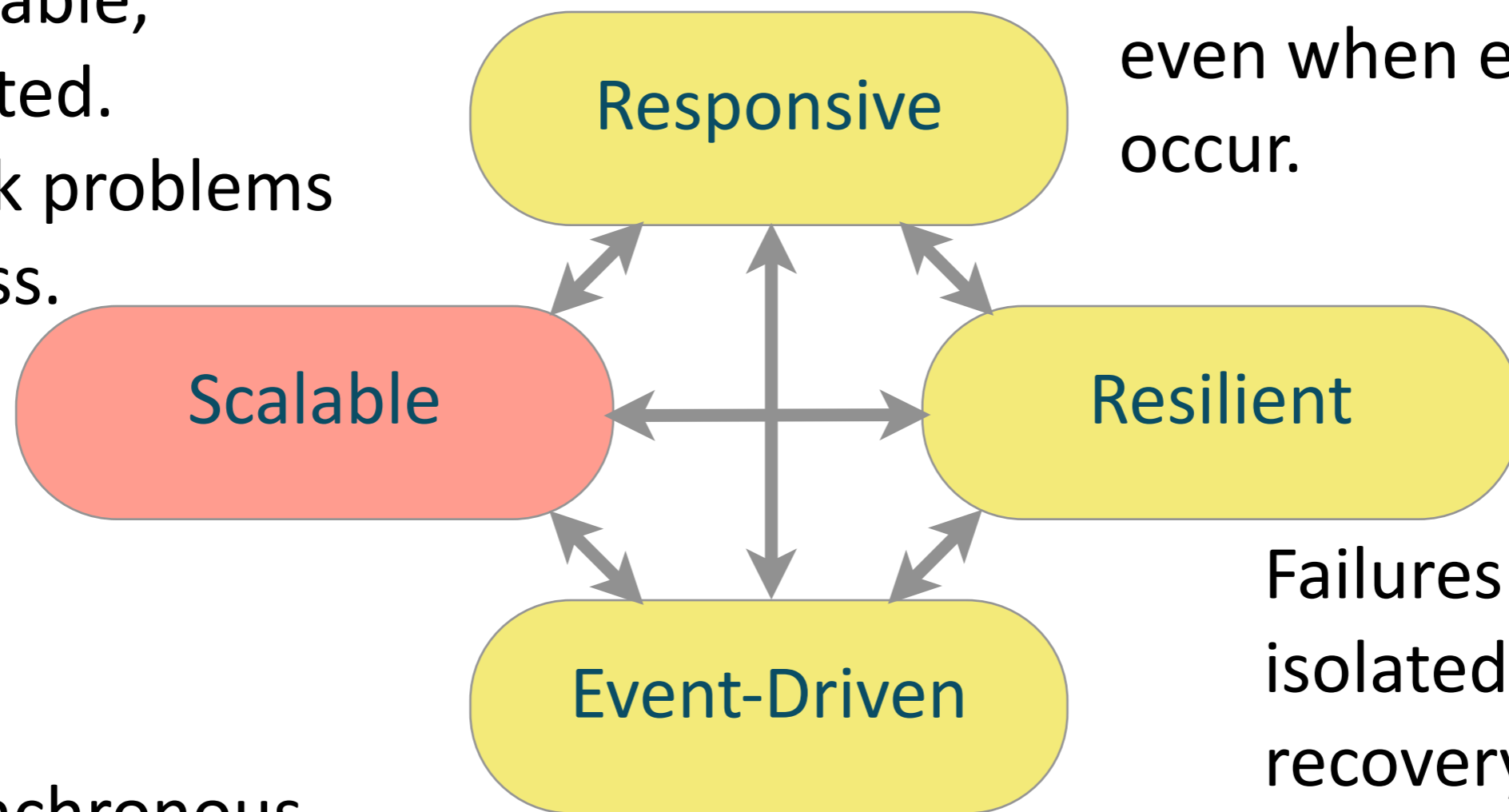

Failures first-class,
isolated. Errors/
recovery are just
other events.

Asynchronous,
non-blocking. Facts
as events are pushed.

Tuesday, May 13, 14

Event-Driven: Indirectly through callbacks.

Scalable: Explicit observer logic complicates code quickly. Difficult to distribute.

Resilient: Careful coding required. Little built-in support. Need back pressure handling.

Responsive: Good, due to push notifications, but observer logic blocks and there's no support for back pressure.

Rx vs. Callbacks

- **Inverted Control:**

- *Event Sources:*

- Streams of events
 - Observer management.
 - ... even event and observer composition operations.

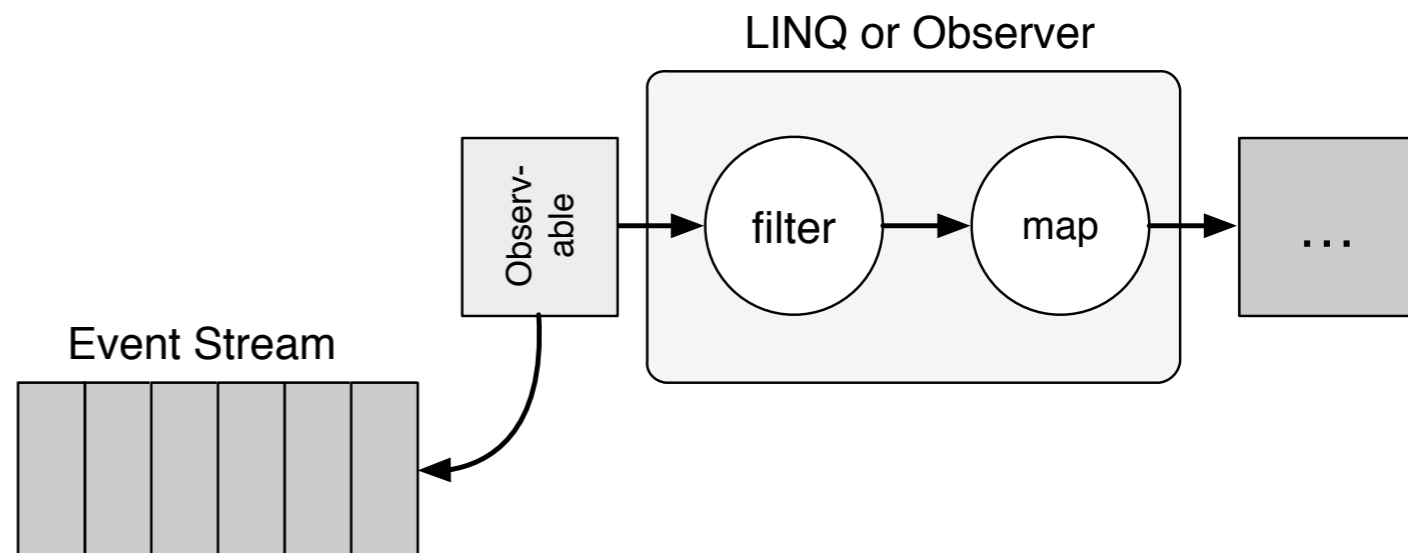

An aerial photograph showing a wide river meandering through a vast agricultural landscape. The fields are a mosaic of various colors, including shades of brown, tan, green, and purple, indicating different crops and stages of growth. The river is a prominent dark blue line that curves and winds across the terrain. The overall scene is a typical rural landscape near Sacramento, California.

Interlude: Reactive Streams

Tuesday, May 13, 14

Photo: Near Sacramento, California

Rx with Backpressure

queue

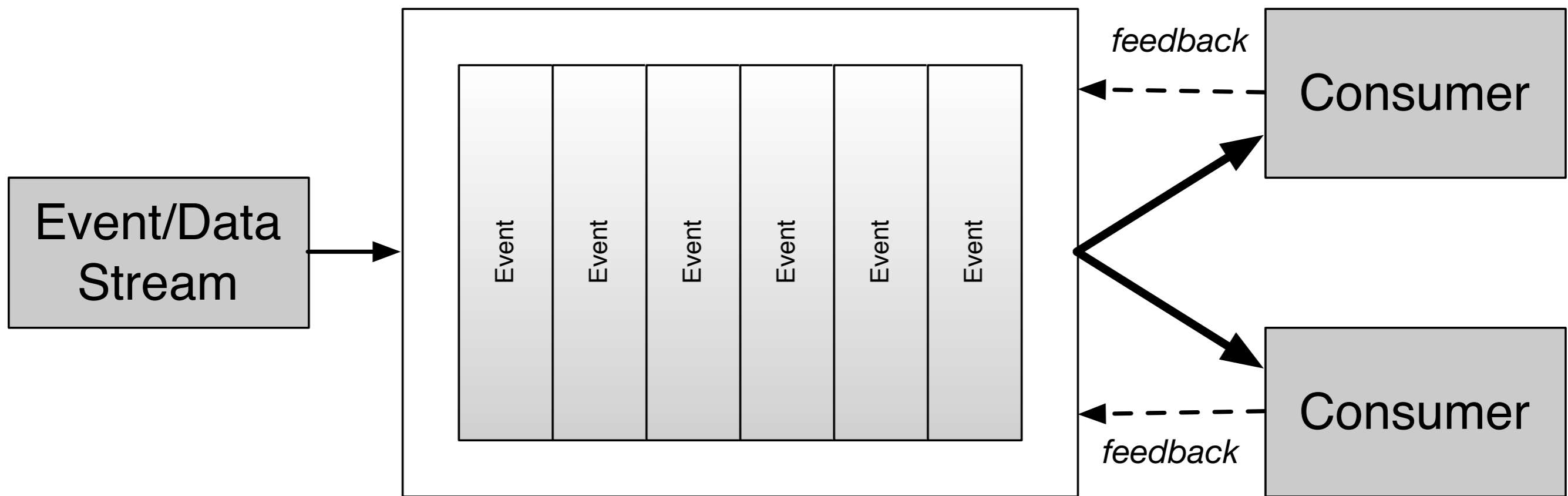

Tuesday, May 13, 14

Asynchronous streams: Support time-varying values as first class.

Back Pressure first class: No explicit mutation or update end-user logic required. And signaling is effectively out of band (think of a priority queue instead of a regular queue...).

Critique

Loosely coupled,
composable,
distributed.
Network problems
first-class.

Must respond,
even when errors
occur.

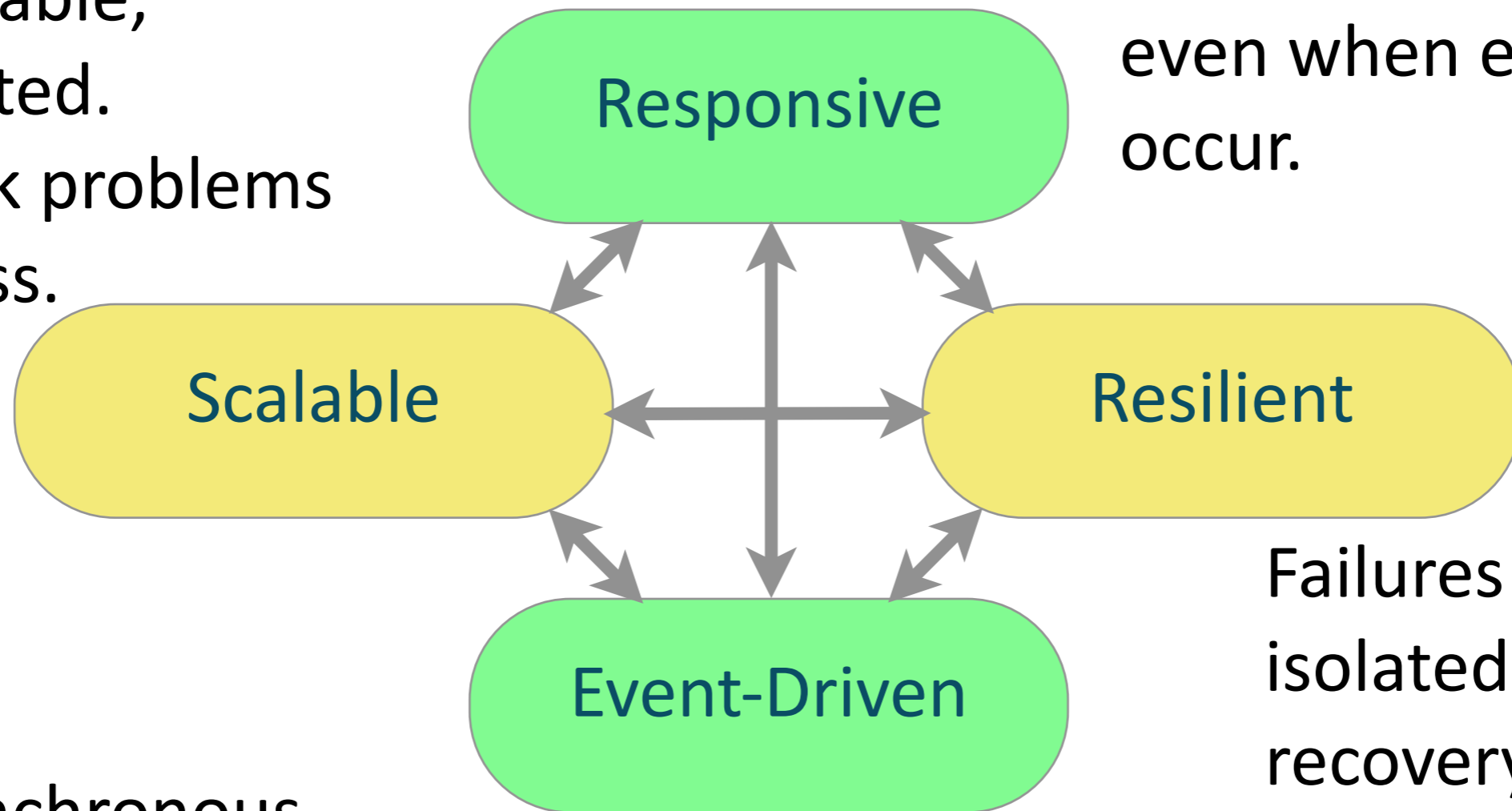

Failures first-class,
isolated. Errors/
recovery are just
other events.

Asynchronous,
non-blocking. Facts
as events are pushed.

Tuesday, May 13, 14

Compared to RX, adding backpressure turns responsive “more” green.

Event-Driven: First class.

Scalable: Designed for high performance, but for horizontal scaling, need independent, isolated instances.

Resilient: Doesn't provide failure isolation, error recovery, like an authority to trigger recovery, but back pressure eliminates many potential problems.

Responsive: Excellent, due to nonblocking, push model, support for back pressure.

Futures



Tuesday, May 13, 14

Photo: Grand Canyon National Park

Ex: Scatter/Gather

- Sum large matrix of numbers, using divide and conquer:

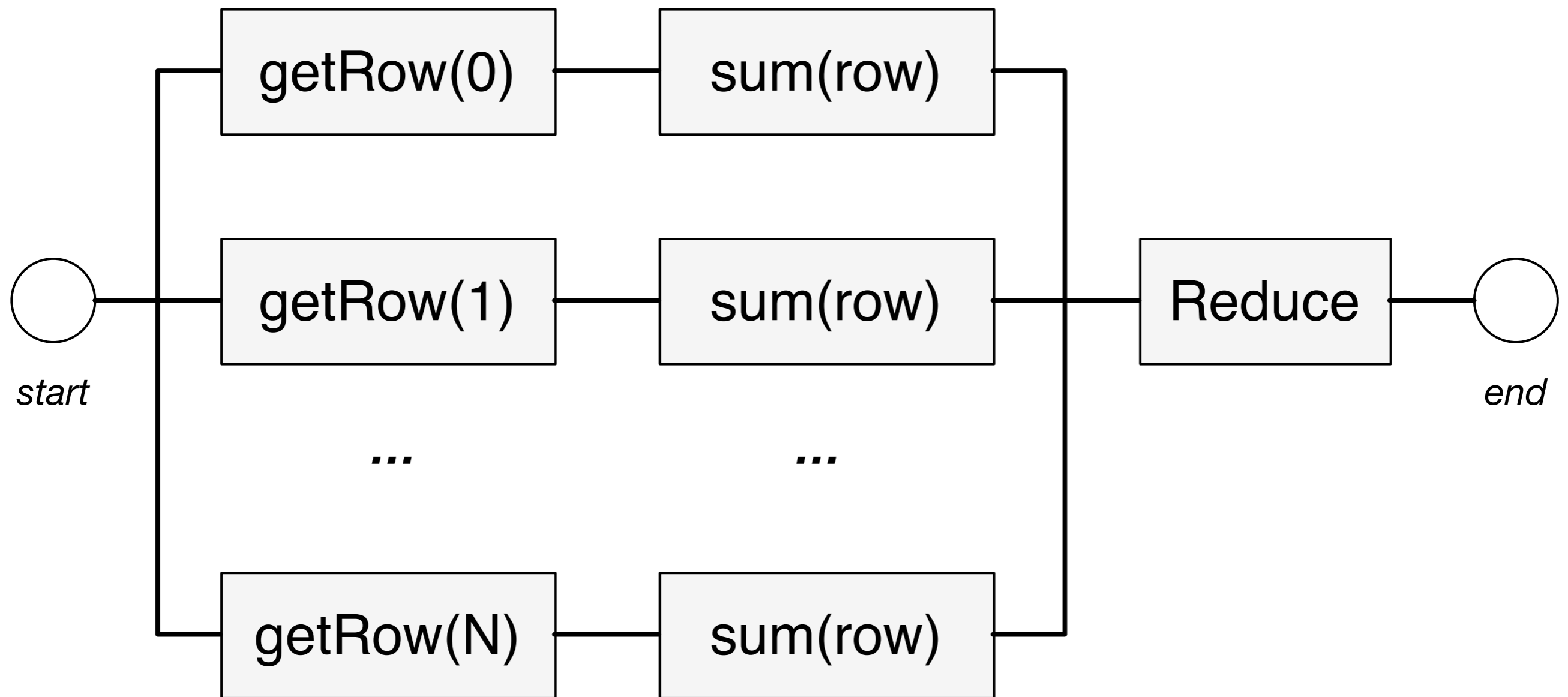

Tuesday, May 13, 14

Dataflow graph construction!

Note that each row is synchronous, but the rows run in parallel. They “rendezvous” at the fold. In other words, this is a dataflow graph.

This is a “batch-mode” example; assumes all the data is present, it’s not a data pipeline.

Can also use futures for event streams, but you must instantiate a new dataflow for each event or block of events.

```
def sumRow(i: Int): Future[Long] =  
    Future(getRow(i)).map(row => sum(row))  
  
val rowSumFutures: Seq[Future[Long]] =  
    for (i <- 1 to N) yield sumRow(i)  
  
val result = Future.reduce(rowSumFutures) {  
    (accum, rowSum) => accum + rowSum2  
} // returns Future[Long]  
  
println(result.value)  
// => Some(Success(a_big_number))
```

Tuesday, May 13, 14

This example assumes I have an NxN matrix of numbers (longs) and I want to sum them all up. It's big, so I'll sum each row in parallel, using a future for each one, then sum those sums. Note that "sumRow" sequences two futures, the first to get the row (say from some slow data store), then it maps the returned row to a call to "sum(row)" that will be wrapped inside a new Future by the "map" method. "sum" (sum the Long values in a row) and "getRow" (get a row from a matrix) functions not shown, but you can guess what they do.

This is a "batch-mode" example; assumes all the data is present.

Can also use futures for event streams.

Critique

Loosely coupled,
composable,
distributed.
Network problems
first-class.

Must respond,
even when errors
occur.

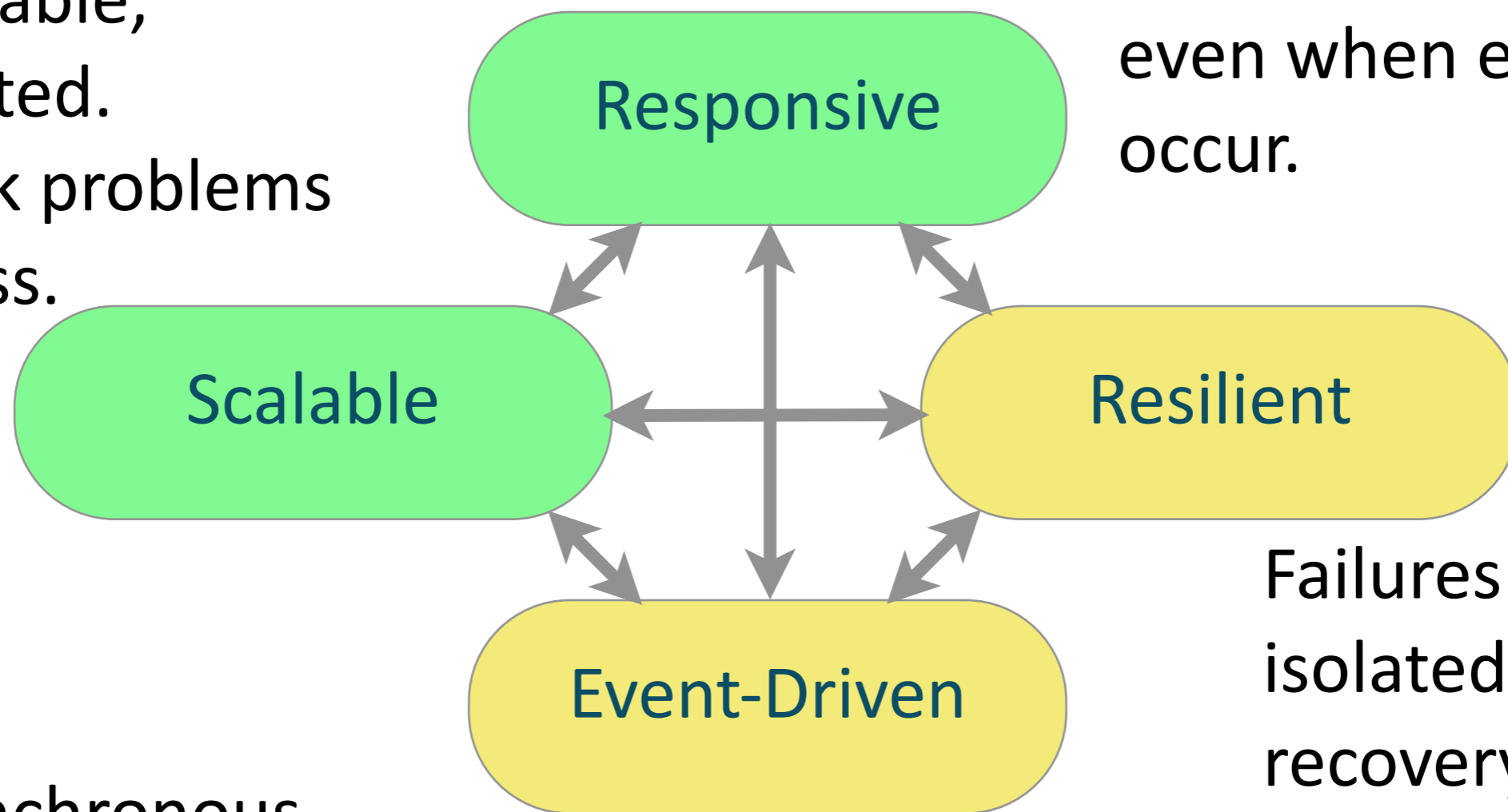

Failures first-class,
isolated. Errors/
recovery are just
other events.

Asynchronous,
non-blocking. Facts
as events are pushed.

Tuesday, May 13, 14

Event-Driven: You can handle events with futures, but you'll have to write the code to do it.

Scalable: Improves performance by eliminating blocks. Easy to divide & conquer computation, but management burden for lots of futures grows quickly.

Resilient: Model provides basic error capturing, but not true handling and recovery. If there are too many futures many will wait for available threads. The error recovery consists only of stopping a sequence of futures from proceeding (e.g., the map call on the previous page). A failure indication is returned. However, there is no built-in retry, and certainly not for groups of futures, analogous to what Actor Supervisors provides.

Responsive: Very good, due to nonblocking model, but if you're not careful to avoid creating too many futures, they'll be "starved" competing for limited threads in the thread pool.

Actors



Tuesday, May 13, 14

Photo: San Francisco Sea Gull... with an attitude.

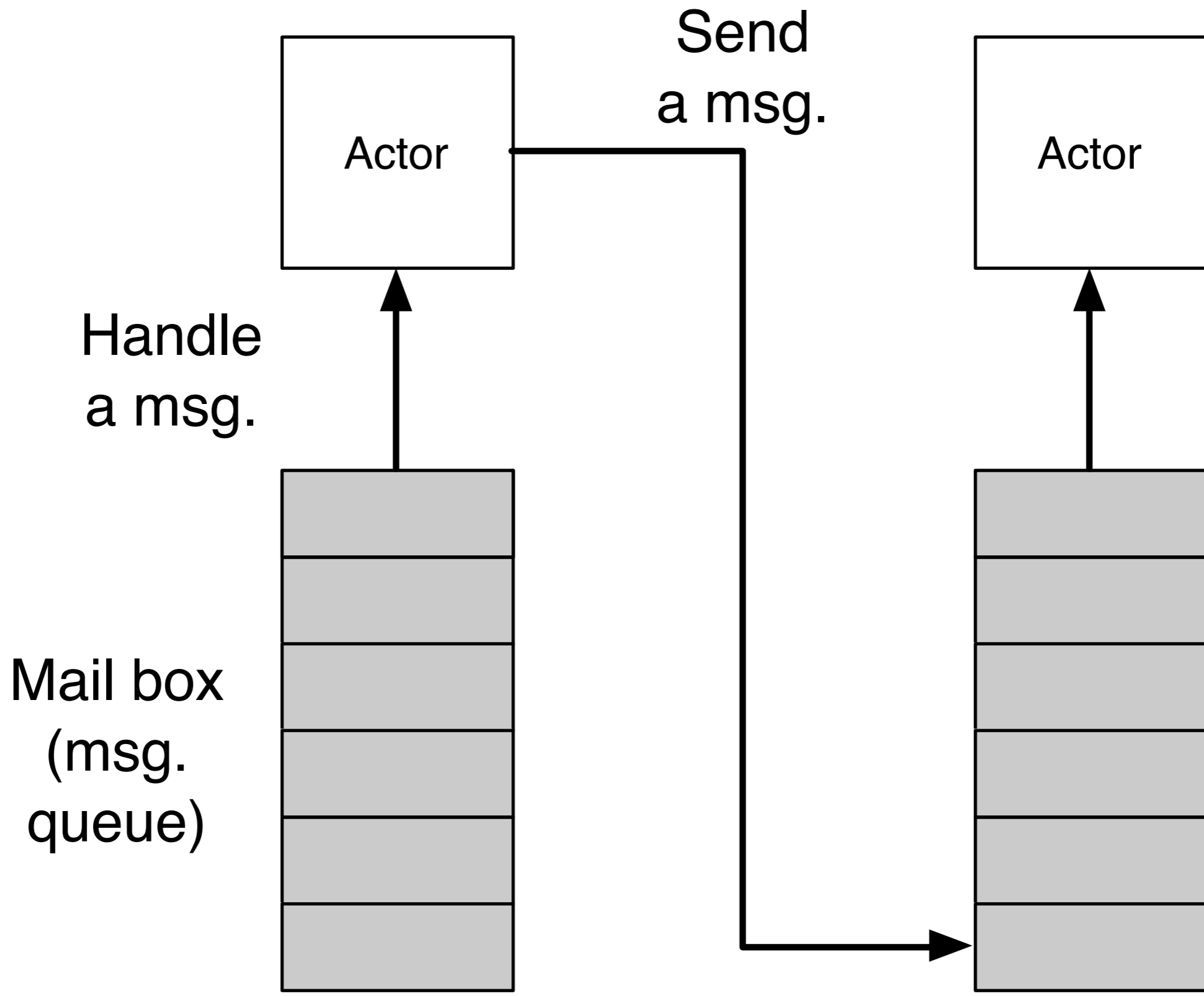

Tuesday, May 13, 14
Synchronization through nonblocking, asynchronous messages. Sender-receiver completely decoupled. Messages are immutable values.
Each time an actor processes a message: 1) The code is thread-safe. 2) The actor can mutate state safely.

Actors

- **Best of breed error handling:**
 - *Supervisor hierarchies of actors* dedicated to lifecycle management of workers and sophisticated error recovery.
- **Actor Model**
 - First class concept in Erlang!
 - Implemented with libraries in other languages.

Critique

Loosely coupled,
composable,
distributed.
Network problems
first-class.

Must respond,
even when errors
occur.

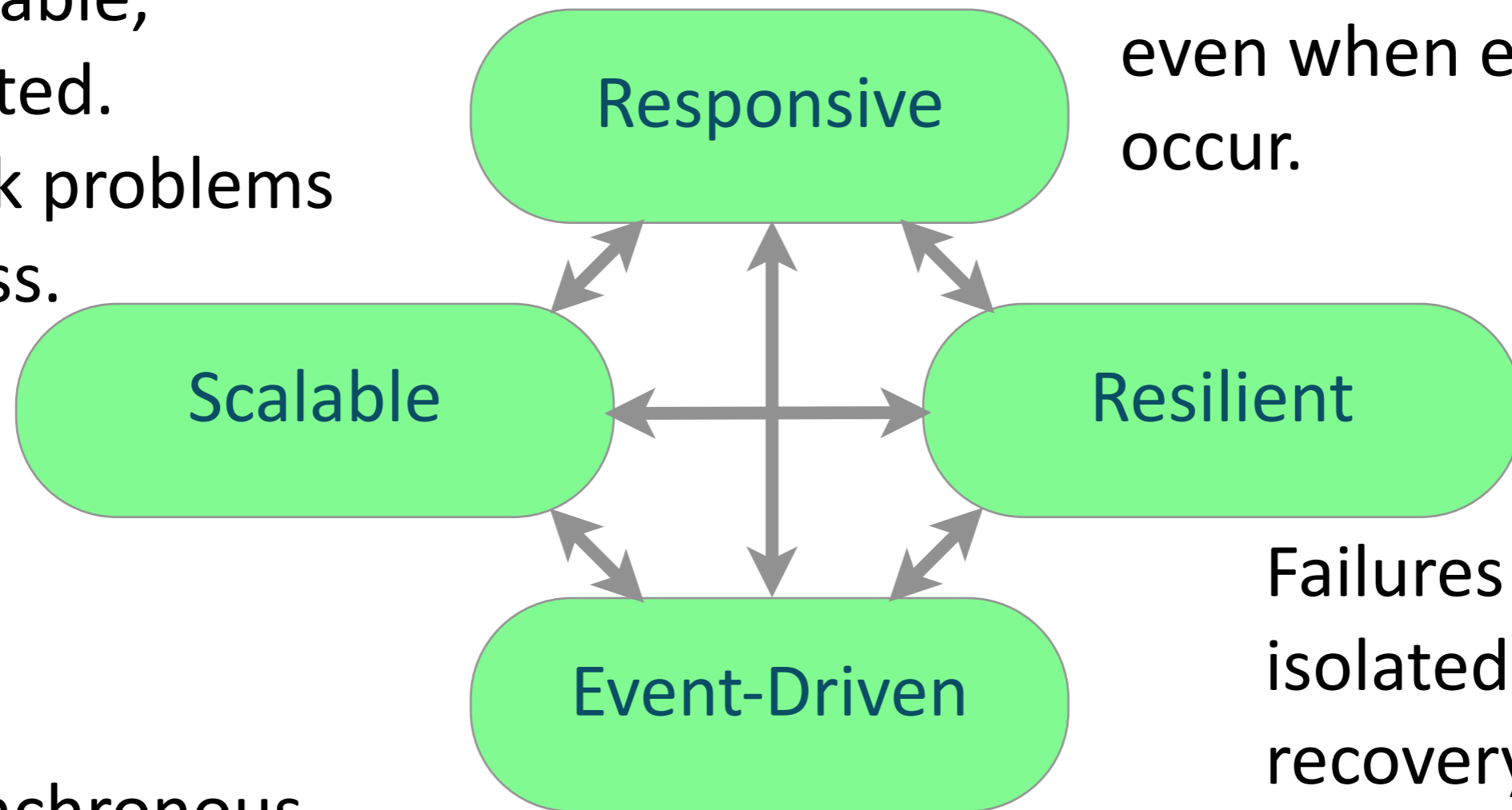

Failures first-class,
isolated. Errors/
recovery are just
other events.

Asynchronous,
non-blocking. Facts
as events are pushed.

Tuesday, May 13, 14

Event-Driven: Events map naturally to messages, stream handling can be layered on top.

Scalable: Improves performance by eliminating blocks. Easy to divide & conquer computation. Principled encapsulation of mutation.

Resilient: Best in class for actor systems with supervisor hierarchies.

Responsive: Good, but some overhead due to message-passing vs. func. calls.

Conclusions



Tuesday, May 13, 14

Photo: Sunset from Hublein Tower State Park, Simsbury, Connecticut.

Every good idea is good or bad
in a context.

Tuesday, May 13, 14

A lot of ideas will be good in some contexts, but not others. I think the Design Patterns movement embraced this well by explicitly describing the appropriate context for each pattern. Mostly, my goal with this talk is to encourage you to question everything and make sure you really understand the strengths and weaknesses of all your design choices, whether or not you're building a reactive system.

Every good idea has a cost,
including abstraction.

Tuesday, May 13, 14

There are no “free” wins. We often think of introducing an abstraction as a “pure win”, but in fact, abstractions have their own costs that must be weighed (e.g., performance, obscurity of actual behavior, etc.)

*Perfection is achieved,
not when there is
nothing left to add,
but when there is
nothing left to remove.*

-- Antoine de Saint-Exupery

*Everything should be made
as simple as possible,
but not simpler.*

-- Albert Einstein



 **Typesafe**

Dean Wampler
dean.wampler@typesafe.com
@deanwampler
polyglotprogramming.com/talks

Tuesday, May 13, 14

Copyright (c) 2005-2014, Dean Wampler, All Rights Reserved, unless otherwise noted.

Image: My cat Oberon, enjoying the morning sun...

Bonus Slides

A photograph of a city skyline on a foggy day. Several tall buildings with many windows are visible, their details softened by the mist. The sky is a uniform, light grey color. The overall mood is quiet and atmospheric.

Four Traits of Reactive Programming

reactivemanifesto.org

Tuesday, May 13, 14

Photo: Foggy day in Chicago.

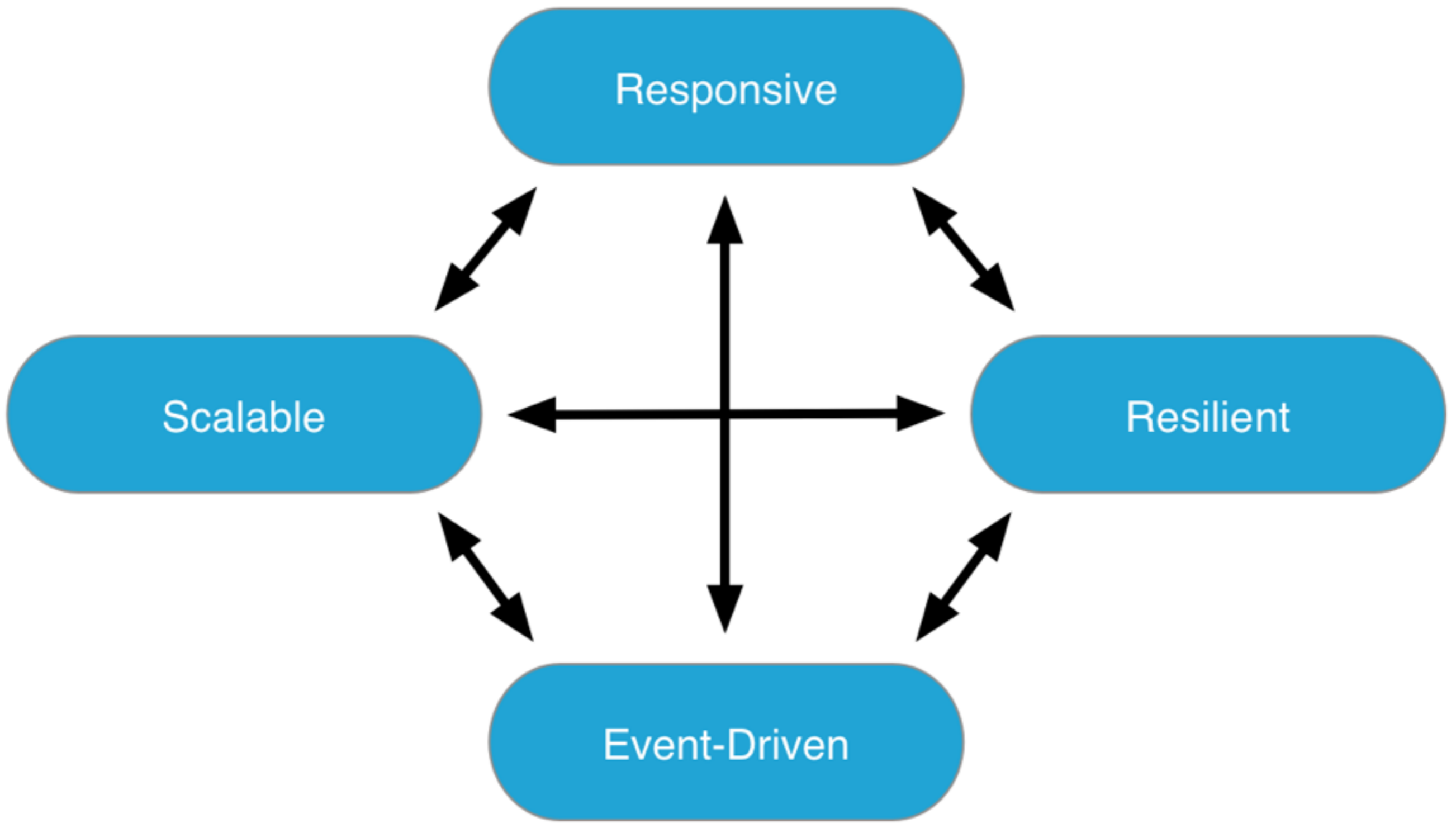

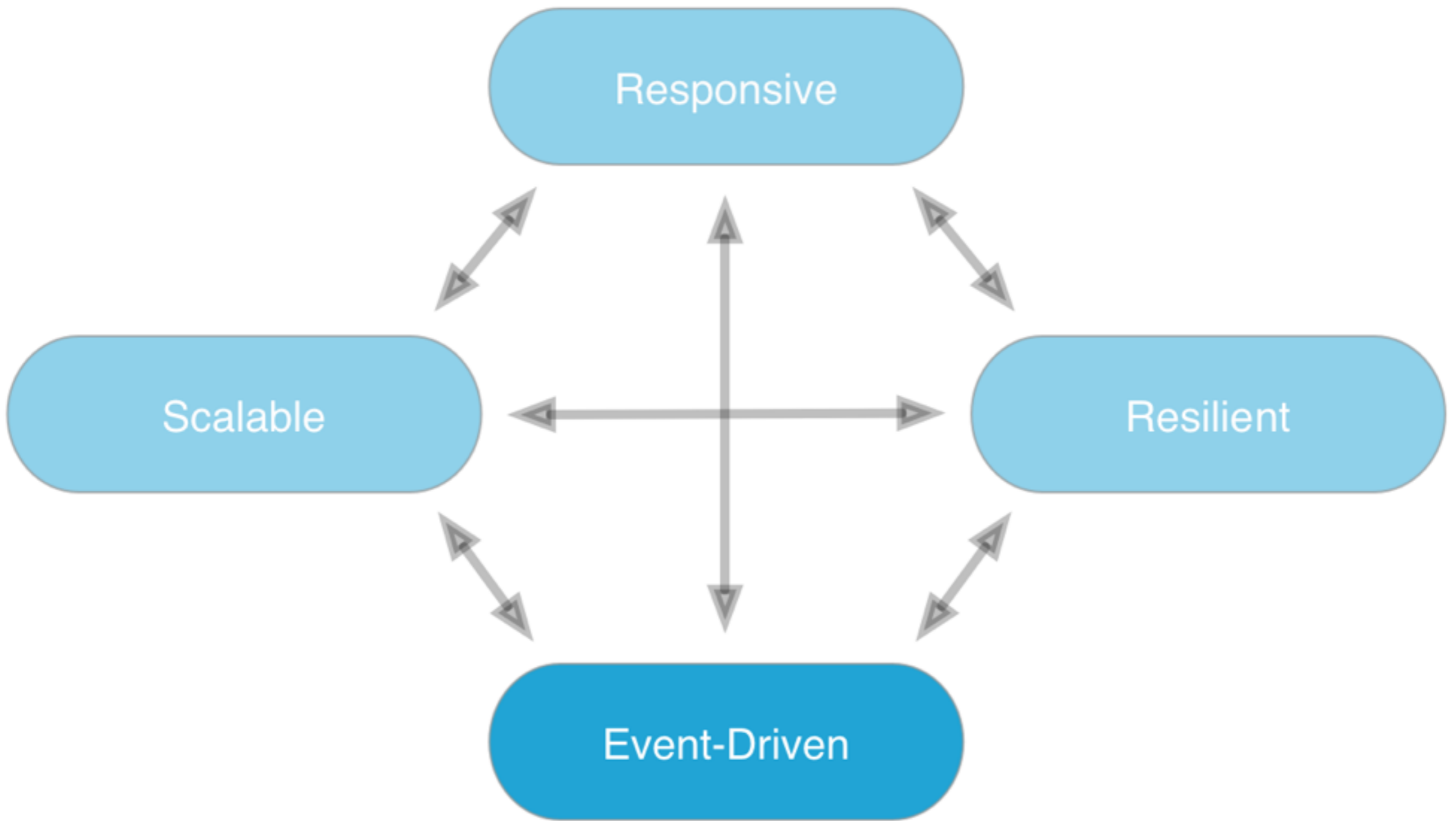

System is driven by events

- **Asynchronous, nonblocking communication:**

- Improved latency, throughput, and resource utilization.

- ***Push* rather than *pull*:**

- More flexible for supporting other services.

- **Minimal interface between modules:**

- Minimal coupling.
- Messages state *minimal facts*.

Event-Driven

Responsive

Scalable

Resilient

Tuesday, May 13, 14

A sender can go onto other work after sending the event, optionally receiving a reply message later when the work is done.

Events abstract over the mechanism of information exchange. It could be implemented as a function call, a remote procedure call, or almost any other mechanism. Hence coupling is minimized, promoting easier independent evolution of modules on either side.

Push driven events mean the module reacts to the world around it, rather than try to control the world itself, leading to much better flexibility for different circumstances.

Facts should be the smallest possible information necessary to convey the meaning.

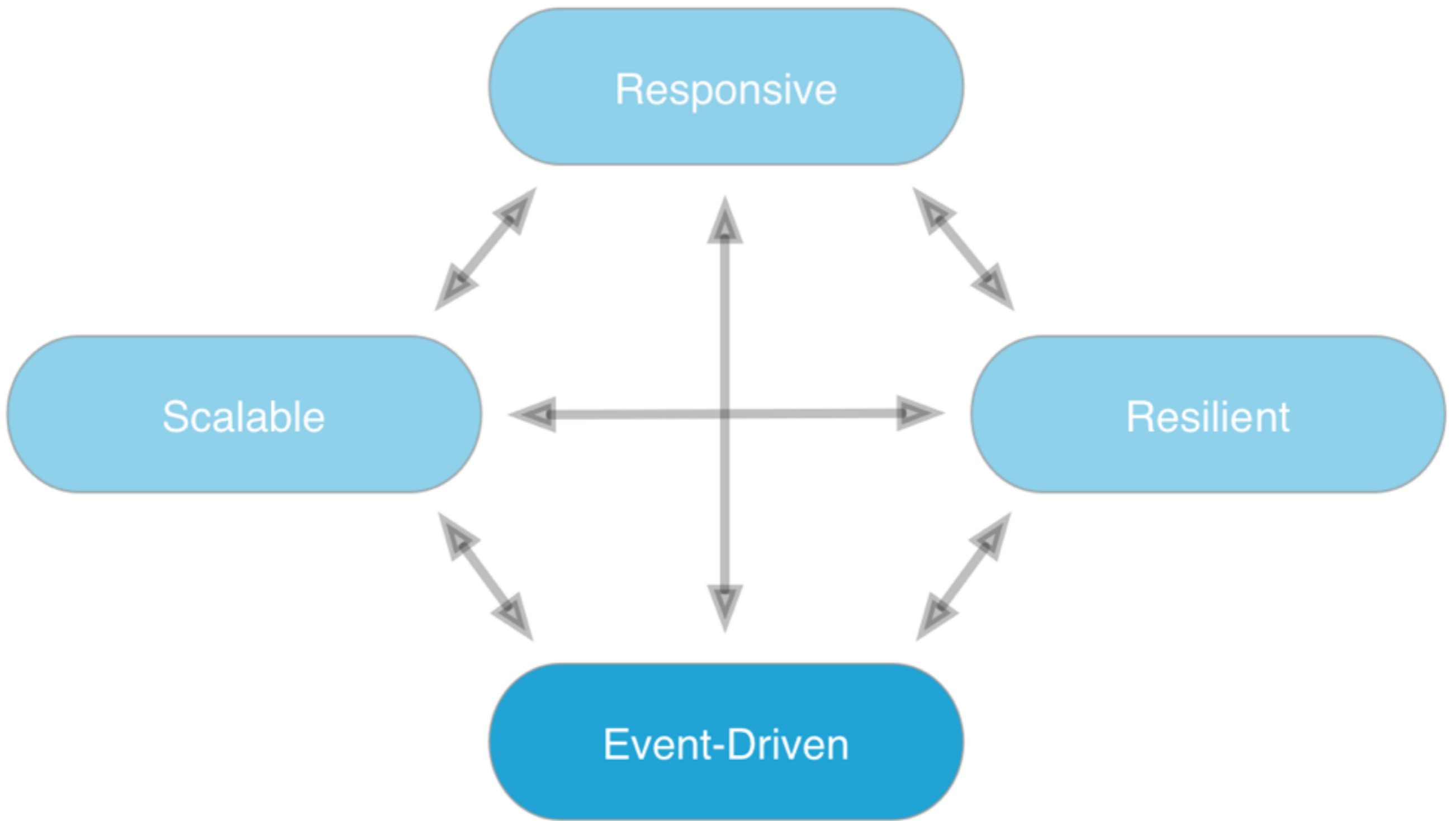

Scale thru contention avoidance

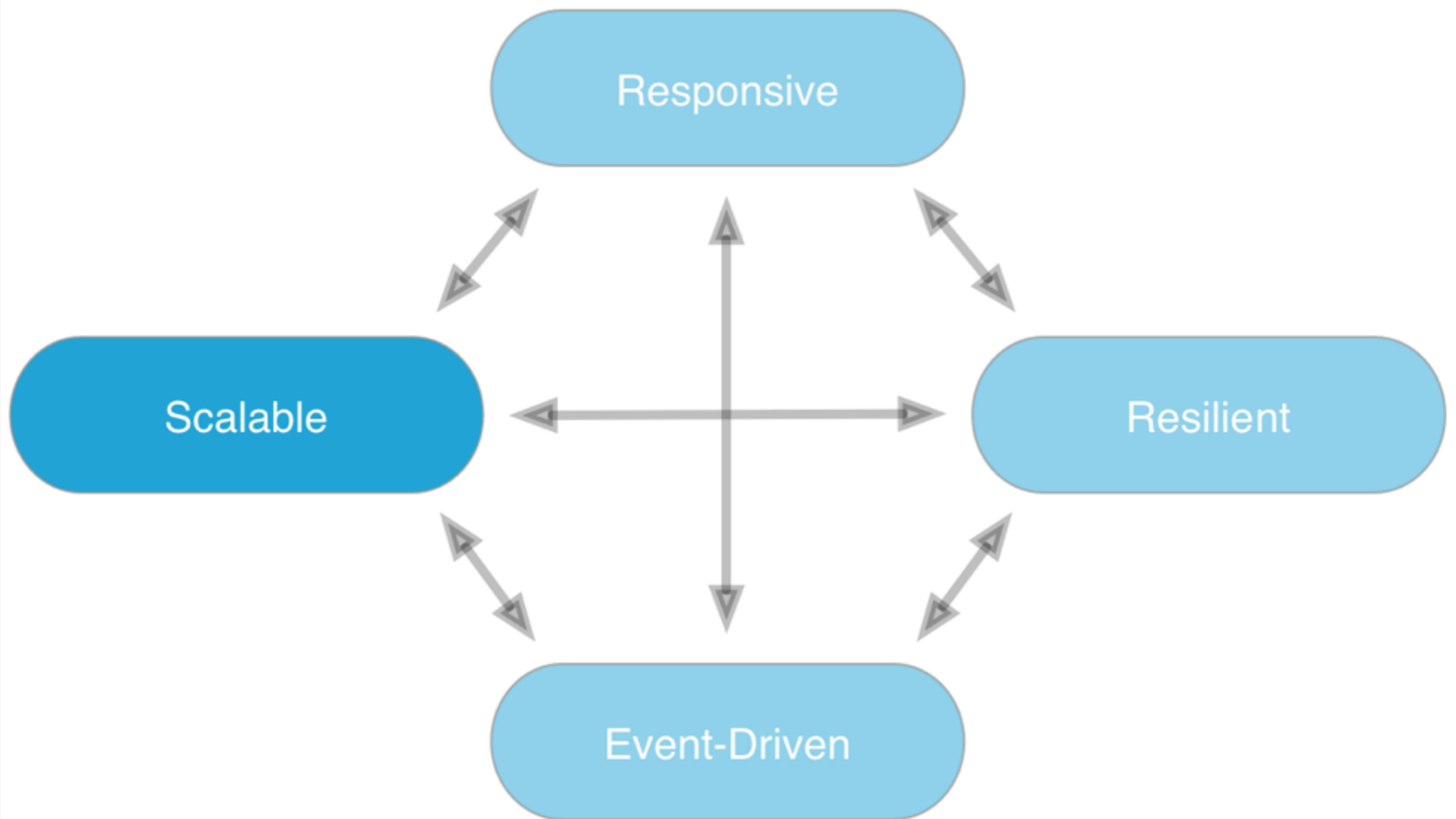

Scale thru contention avoidance

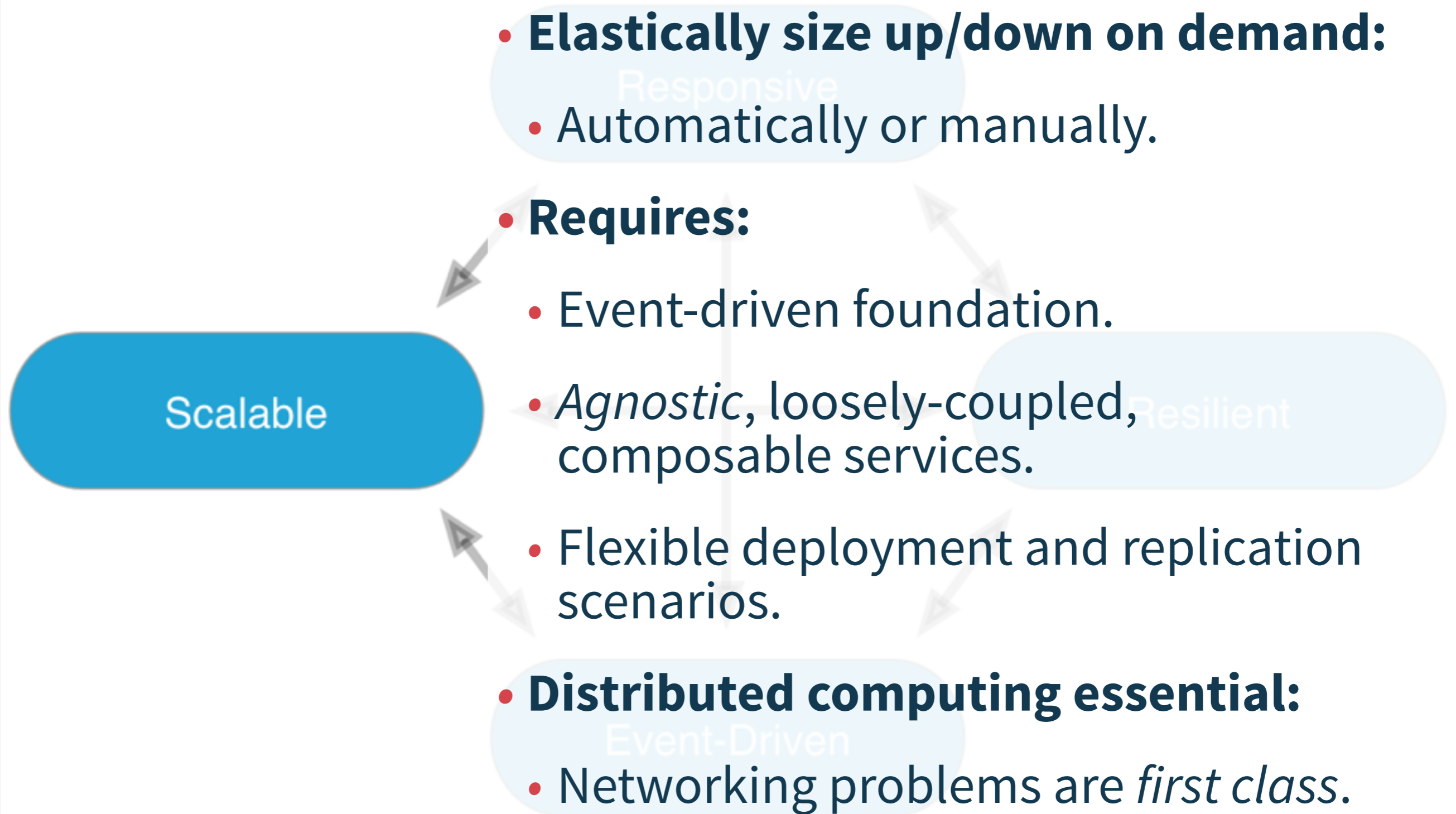

Tuesday, May 13, 14

Automatic elastic sizing may not be possible in all circumstances and with all tool kits. It's easier in a cloud environment, in general.

Agnostic services know only what they need to know, no more or less. Otherwise, it's harder to decouple

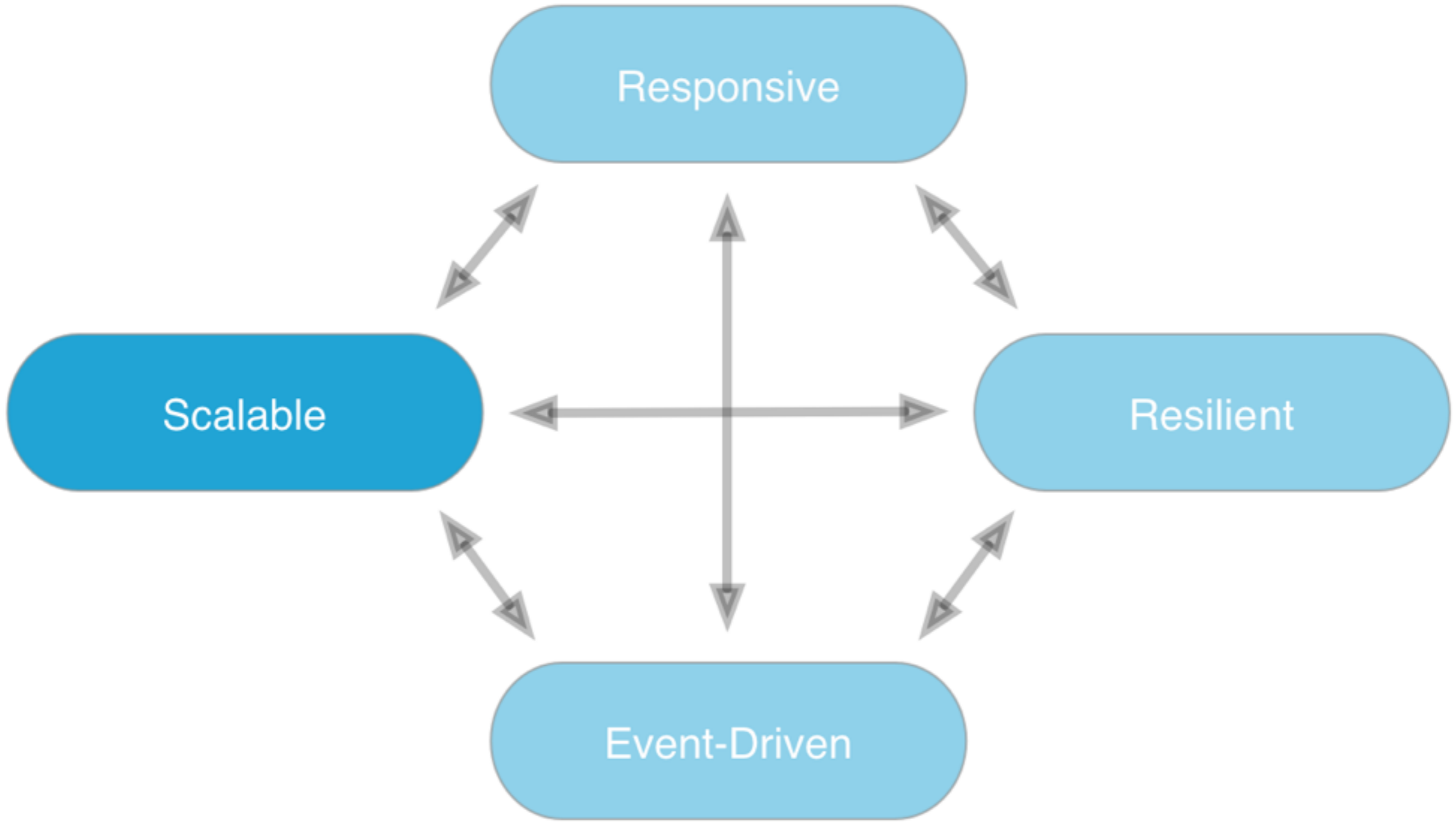

Recover from failure

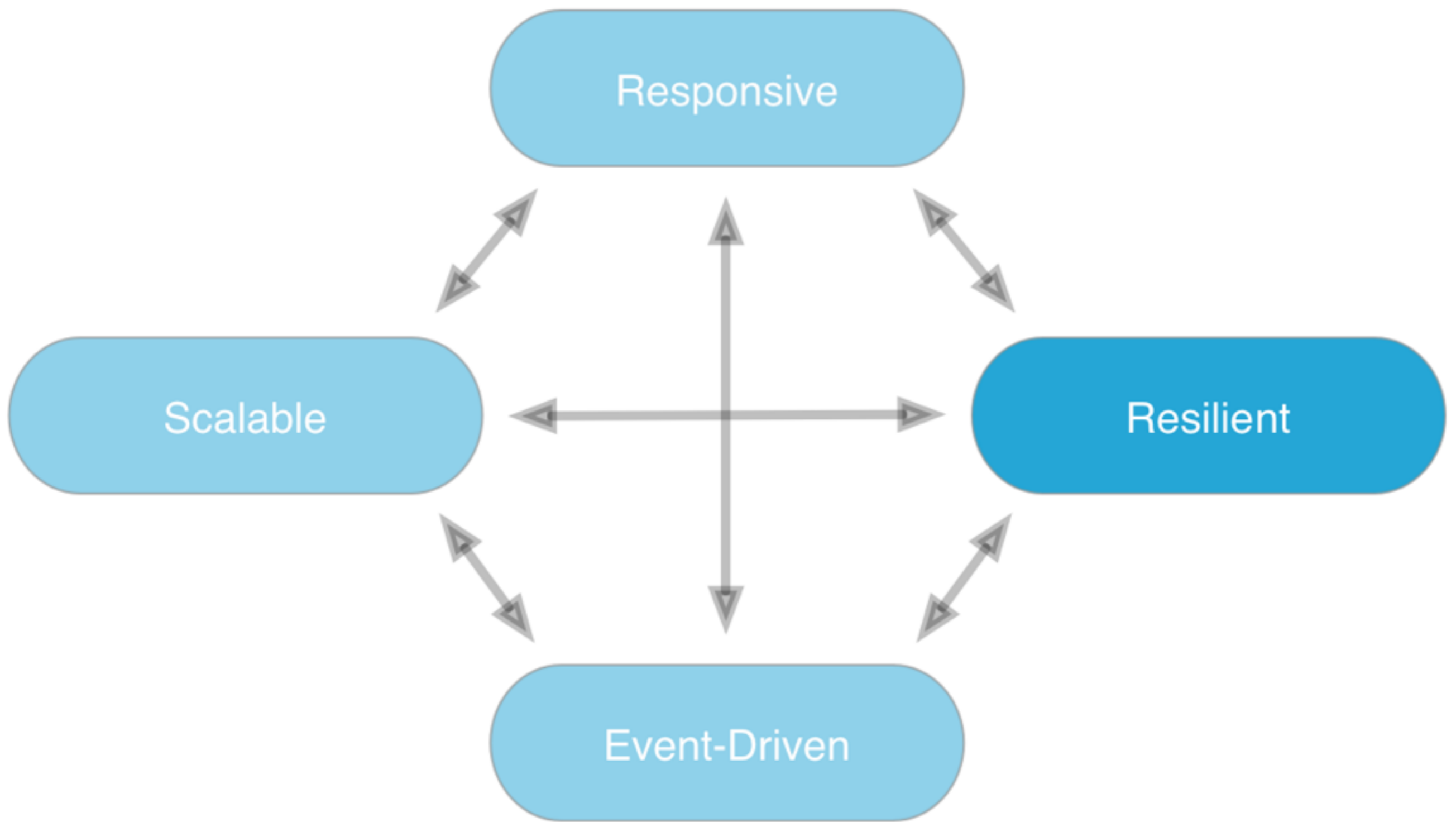

Recover from failure

- **Failure is first class:**

- Bolt-on solutions, like failover, are inadequate.
- Fine-grain, built-in recovery is *fundamental*.

- **Requires:**

- Isolation (“bulkheads”).
- Separation of business logic from error channel.
- Reification of failures and recovery.
- Authority that listens for errors and triggers recovery.

The diagram features a central blue rounded rectangle labeled "Resilient" on the right. To its left are three light blue rounded rectangles: "Scalable" at the top, "Event-Driven" at the bottom, and "Requires:" in the middle. A horizontal double-headed arrow connects "Requires:" to "Resilient". A vertical double-headed arrow connects "Scalable" and "Event-Driven". Four diagonal double-headed arrows connect "Scalable" to "Resilient", "Event-Driven" to "Resilient", "Scalable" to "Requires:", and "Event-Driven" to "Requires:".

Resilient

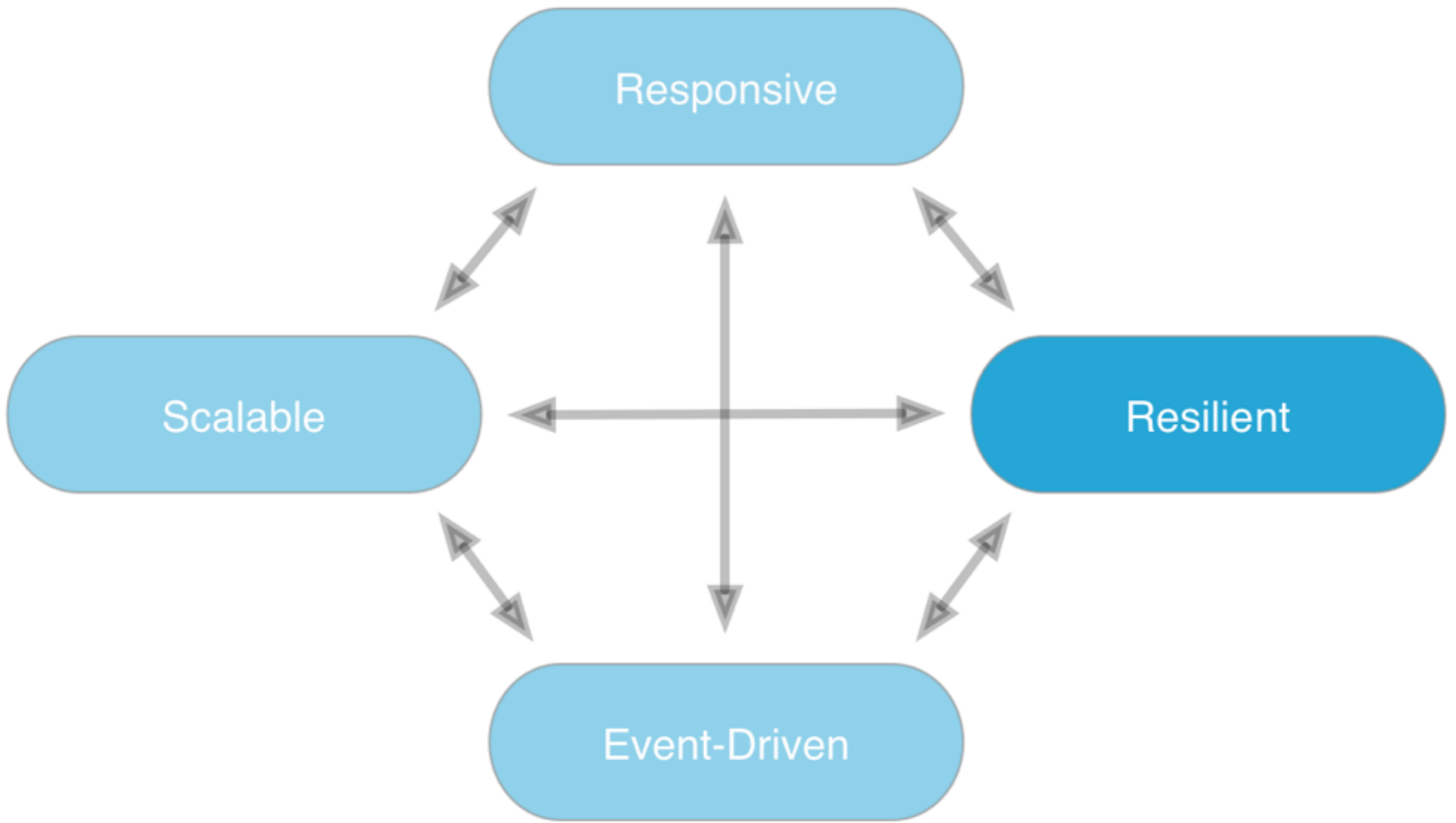

Meet response time SLAs

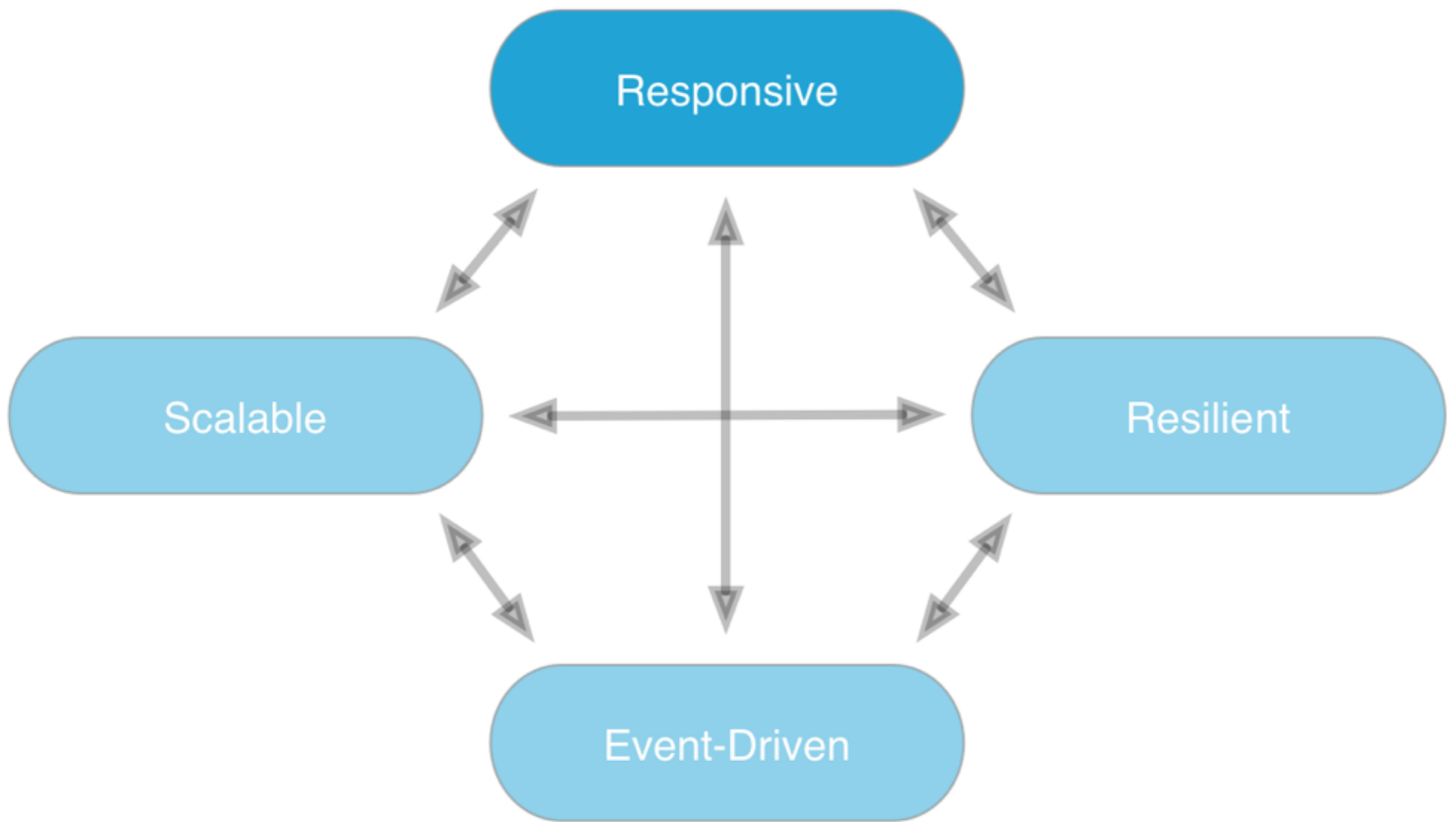

Meet response time SLAs

Responsive

- **Long latency vs. unavailable:**

- Same thing: no service, as far as clients are concerned.

- **Even when failures occur,**

- Provide *some* response.
- *Degrade gracefully.*

Resilient

Event-Driven

Scalable

Meet response time SLAs

- **Requires:**

- Event streams.

Scalable

- Nonblocking mutation operations.

- Fast algorithms. $O(1)$ preferred!

- Bounded queues with back pressure.

- Monitoring and capacity planning.

- Auto-triggered recovery scenarios.

Responsive

Resilient

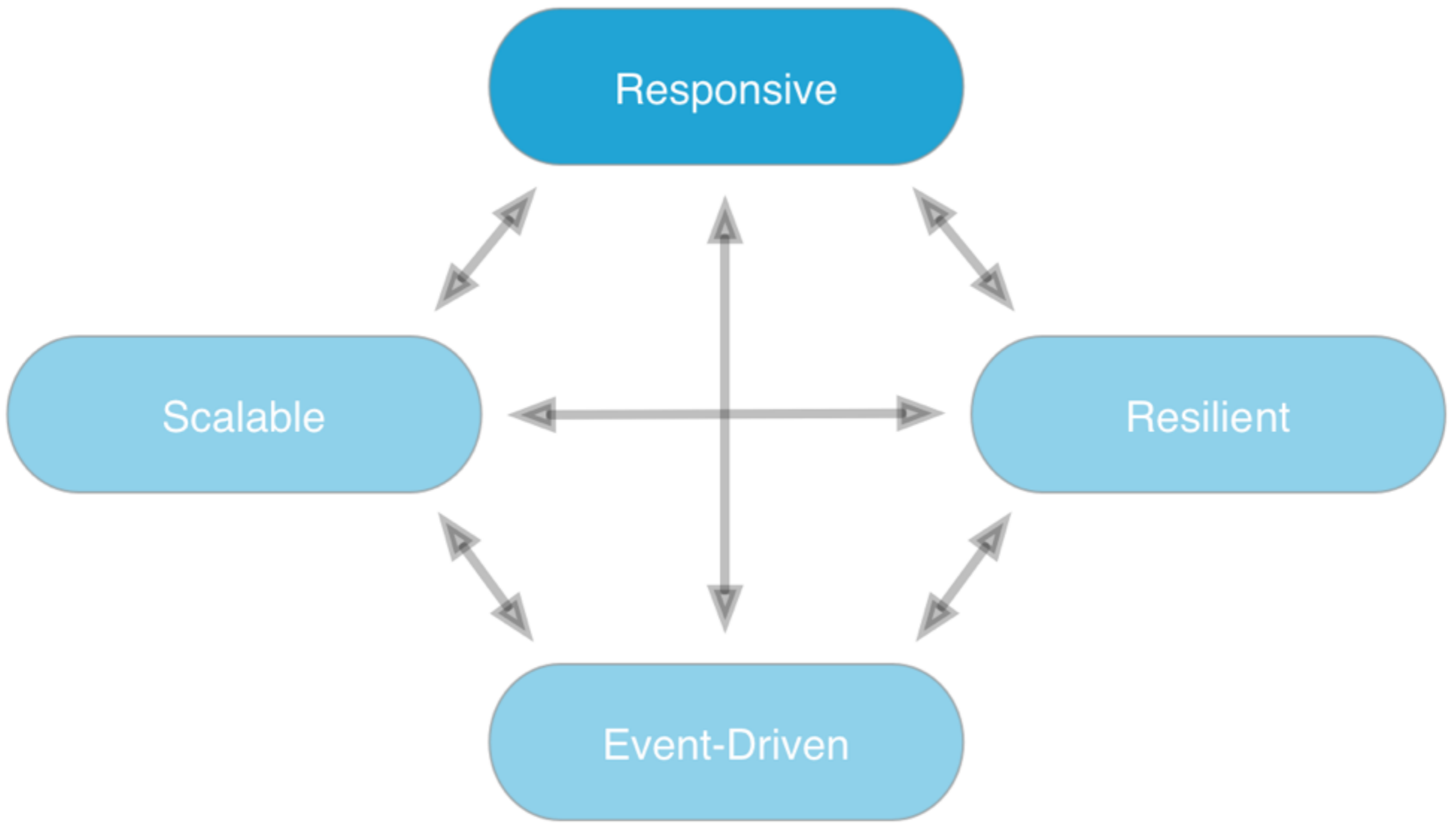

Network problems first-class. Loosely coupled. Composable. Distributed.

Must respond, even when errors occur.

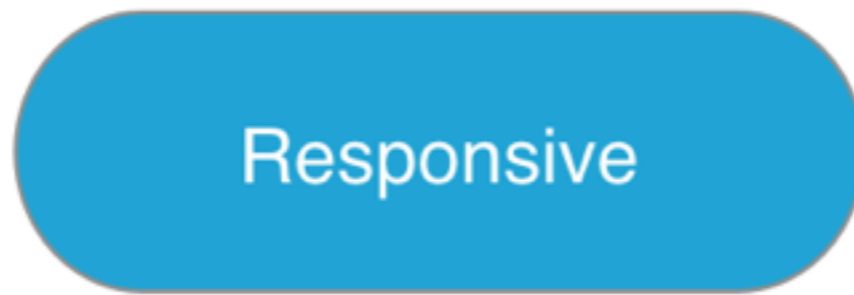
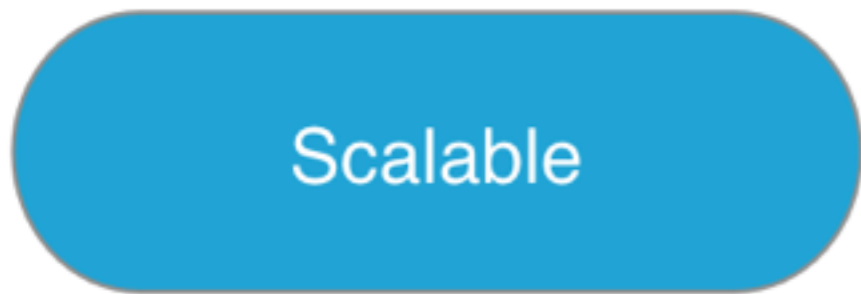

Asynchronous. Non-blocking. Facts as events are pushed.



Failure first-class. Isolation. Errors/recovery are events.

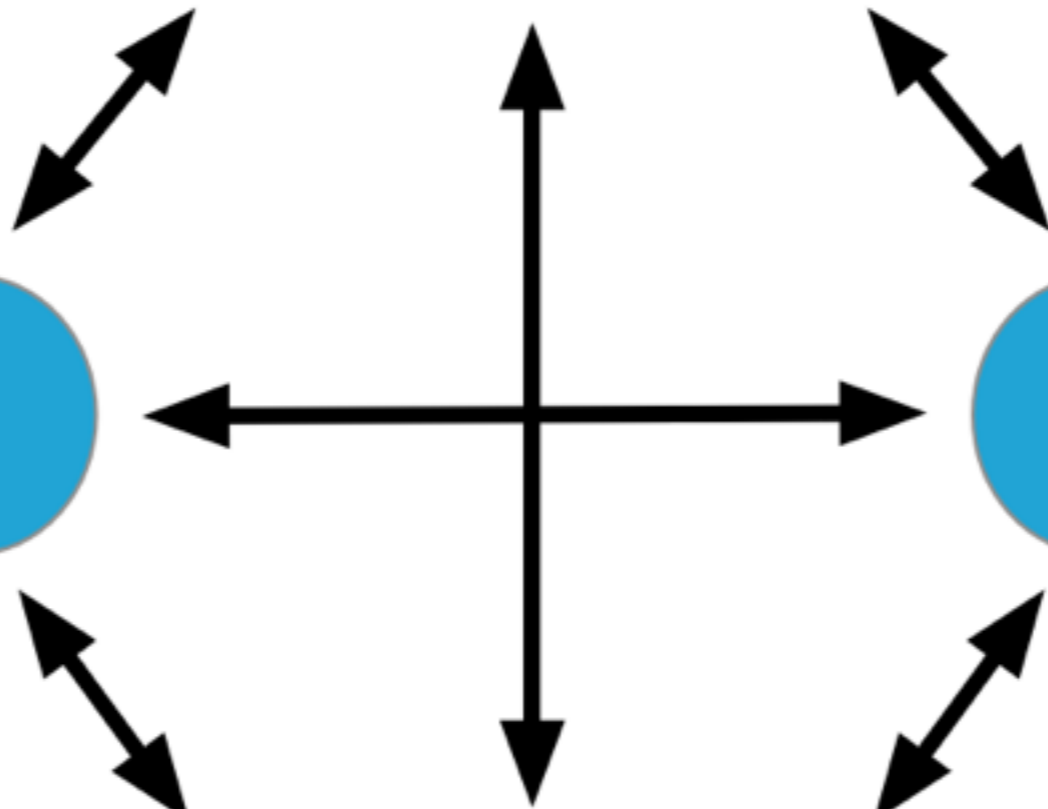



in Robotics

Reactive Programming

Tuesday, May 13, 14

Photo: Escalante Ranger Station,
Utah.

Reactive Programming, AI-style

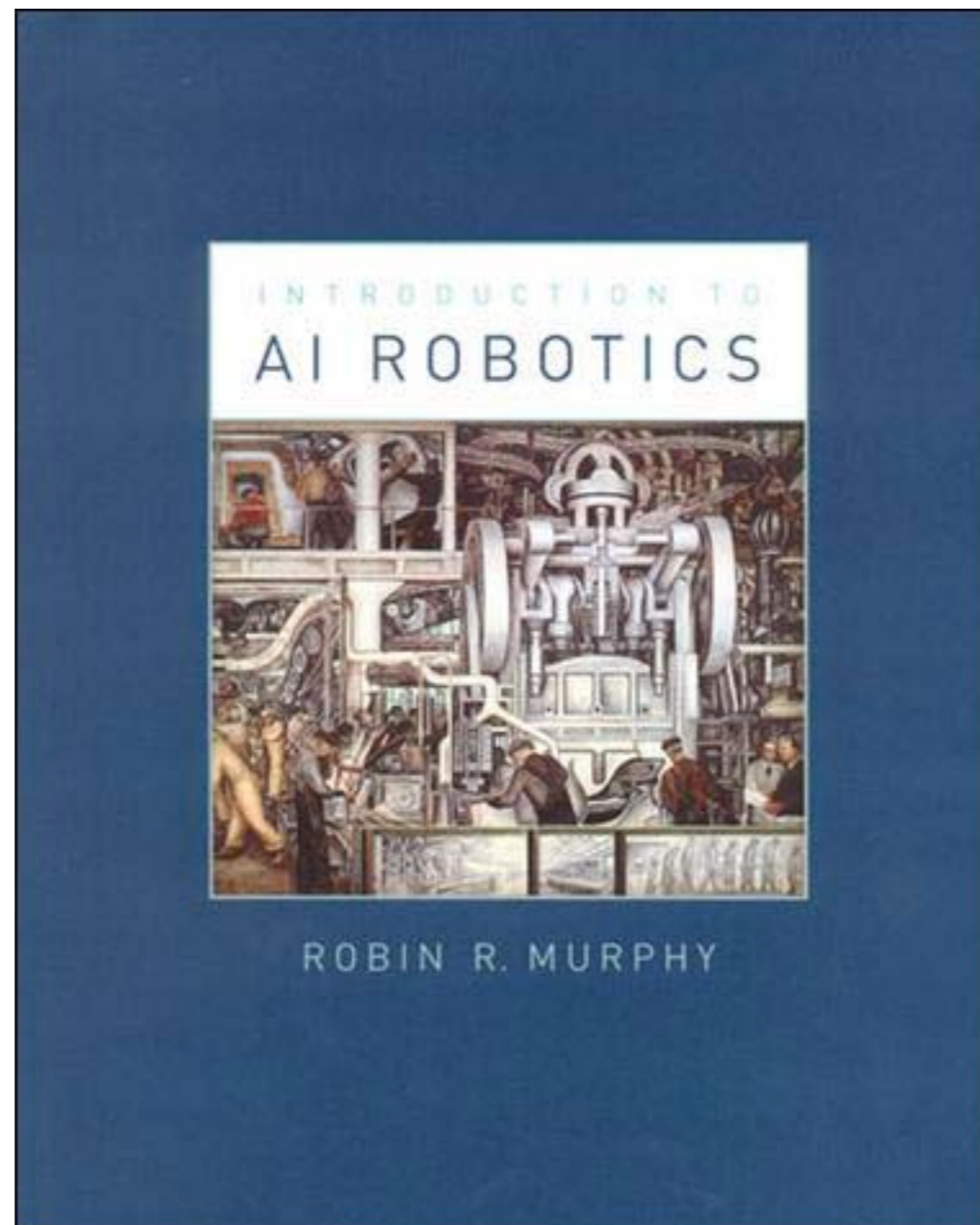

Tuesday, May 13, 14

"Introduction to AI Robotics", MIT Press, 2000. <http://mitpress.mit.edu/books/introduction-ai-robotics>

Reactive Programming, AI-style

- Emerged in the 1980s!
- Vertical composition of behaviors.
 - From basic needs to advanced responses.
 - Inspired by biological systems.

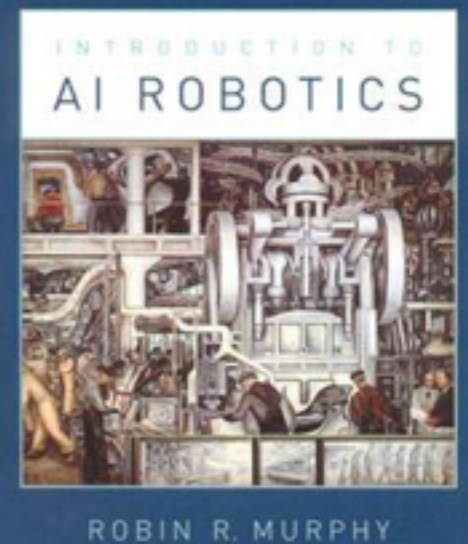

Tuesday, May 13, 14

From "Introduction to AI Robotics", MIT Press, 2000. <http://mitpress.mit.edu/books/introduction-ai-robotics>

Reactive Programming, AI-style

- Replaced earlier *hierarchical models* based on:
 - SENSE
 - PLAN
 - ACT
- Improvements:
 - Faster Reactions to Stimuli.
 - Replaces a global model with a modular model.

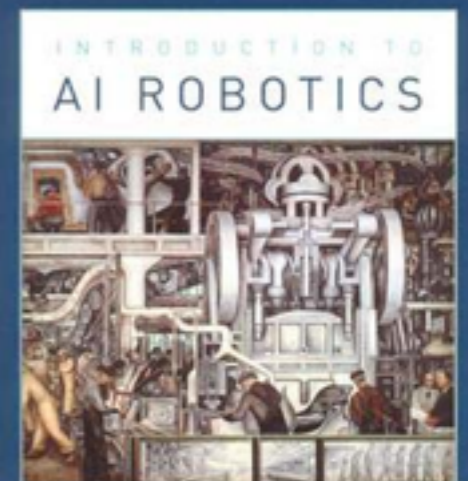

Reactive Programming, AI-style

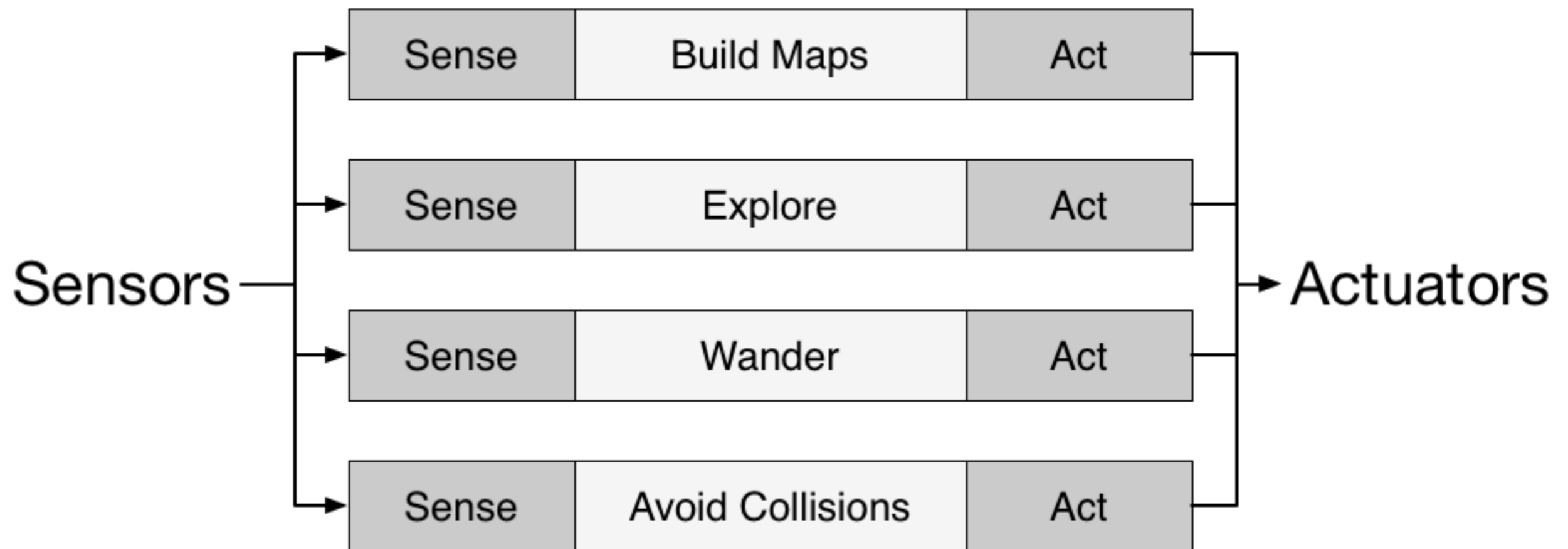

- What if actions conflict?
- We'll come back to that...

Five Characteristics

Tuesday, May 13, 14

5 that are true for the many variants of RP in Robotics.

Robots are situated agents, operating in an ecosystem.

- A robot is part of the ecosystem.
- It has goals and intentions.
- When it acts, it changes the world.
- It receives immediate feedback through measurement.
- It might adapt its goals and intentions.

Behaviors are building blocks of actions. The overall behavior is emergent.

- Behaviors are independent computational units.
- There may or may not be a central control.
- Conflicting/interacting behaviors create the emergent behavior.

Sensing is local, behavior-specific

- Each behaviors may have its own sensors.
 - Although sensory input is sometimes shared.
- Coordinates are robot-centric.
 - i.e., polar coordinates around the current position.
- Conflicting/interacting behaviors create the emergent behavior.

Good Software Development Principles are Used

- Modular decomposition:
 - Well defined interfaces.
 - Independent testing.
 - ...

Animal models are inspirations

- Earlier AI models studiously avoided inspiration from and mimicry of biological systems:
 - Seems kind of stupid now...

Interacting/Conflicting Behaviors?

Reactive Programming, AI-style

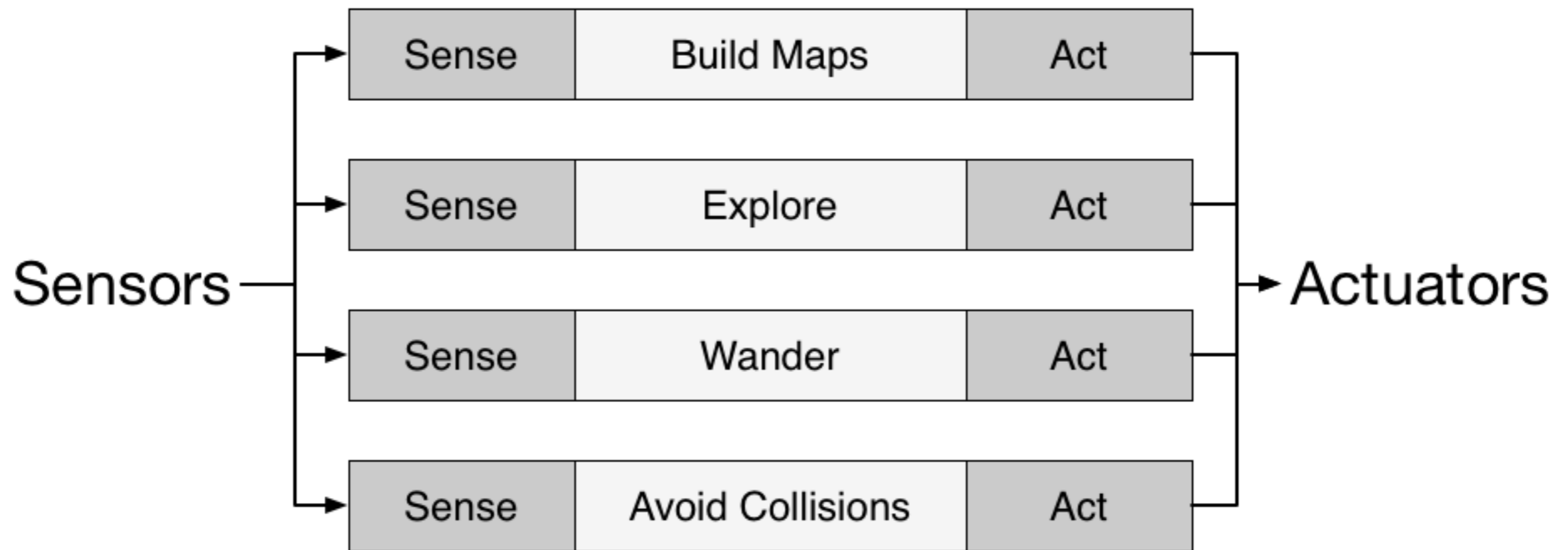

- What if actions conflict?
 - Subsumption
 - Potential Fields

Subsumption

(We won't discuss
potential fields
for times sake.)

Subsumption

- *Behaviors:*
 - A network of sensing and acting *modules* that accomplish a task.
- *Modules:*
 - Finite State Machines augmented with timers and other features.
 - Interfaces to support composition
- There is no central controller.
 - Instead, actions are governed by four techniques:

Modules are grouped into *layers of competence*

- Basic survival behaviors at the bottom.
- More goal-oriented behaviors towards the top.

Modules in the higher layers can *override* lower-level modules

- Modules run concurrently, so an override mechanism is needed.
- *Subsumption* or overriding is used.

Internal state is avoided

- As a situated agent in the world, the robot should rely on real input information.
- Maintaining an internal, imperfect model of the world risks diverging from the world.
- Some modeling may be necessary for some behaviors.

Tasks are accomplished by activating the appropriate layer

- Lower-level layers are activated by the top-most layer, as needed.
- Limitation: Subsumption RP systems often require reprogramming to accomplish new tasks.

Final Example

Object
Oriented!

